

Н. С. Старжинская

ВМК  
«Мае  
першыя  
ўрокі»

ПАДРЫХТОЎКА  
ДА  
НАВУЧАННЯ ГРАМАЦЕ  
РАБОЧЫ СШЫТАК



--	--	--

--	--	--	--

--	--	--	--	--

Н. С. Старжынская

# ПАДРЫХТОЎКА ДА НАВУЧАННЯ ГРАМАЦЕ

## Рабочы сшытак

Вучэбны дапаможнік  
для выхаванцаў старшых груп (ад 5 да 7 гадоў)  
устаноў дашкольнай адукацыі  
з беларускай мовай навучання

*Дарушчана  
Міністэрствам адукацыі  
Рэспублікі Беларусь*

Мінск



Нацыянальны інстытут адукацыі  
2020

УДК 373.2.016:811.161.3  
ББК 74.102  
С77

Серыя заснавана ў 2019 годзе

Р э ц е н з е н т ы:

кафедра дашкольнай і пачатковай адукацыі дзяржаўнай установы адукацыі  
«Мінскі абласны інстытут развіцця адукацыі» (дэкан факультэта павышэння кваліфікацыі кадраў,  
кандыдат псіхалагічных навук, дацэнт кафедры *Т. М. Нядвецкая*);  
намеснік загадчыка па асноўнай дзейнасці дзяржаўнай установы адукацыі  
«Яслі-сад № 132 г. Мінска» *Т. П. Мазурына*

ISBN 978-985-594-509-4

© Старжынская Н. С., 2020

© Афармленне. НМУ «Нацыянальны інстытут адукацыі», 2020

## ЗАДАННІ АБАЗНАЧАНЫ ПІКТАГРАМАМИ



— абвядзі



— падпішы, злучы



— нарысуй, дарысуй



— абазнач і вылучы гук



— вызначы склады ў словах

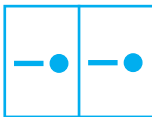

— знайдзі аднолькавыя склады



— прачытай



— упішы літары



— знайдзі лішняе

# ЗАНЯТКИ 1

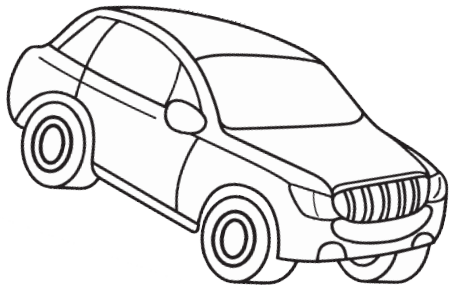
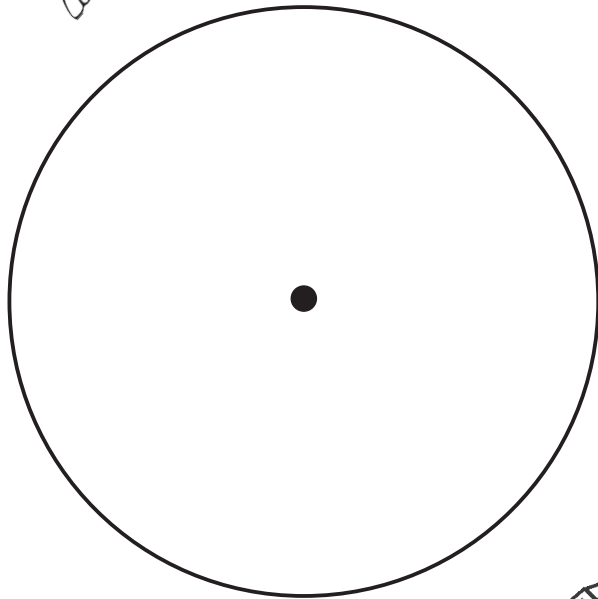
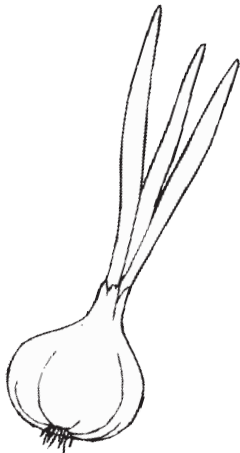
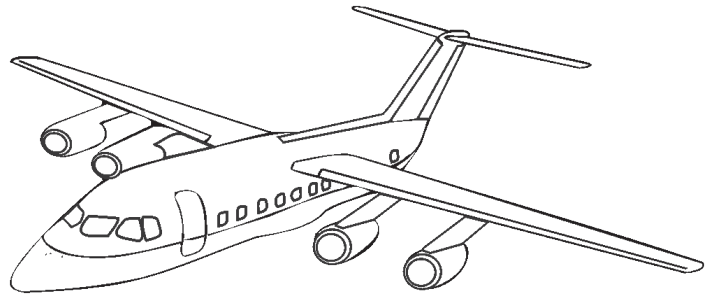
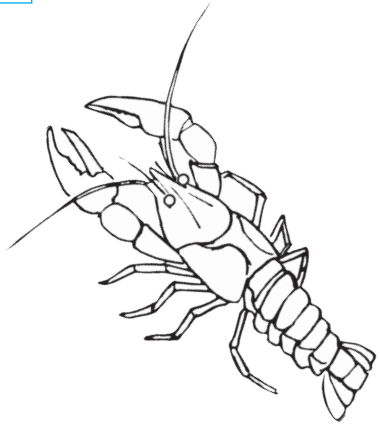

# \*ЗАНЯТКИ 1

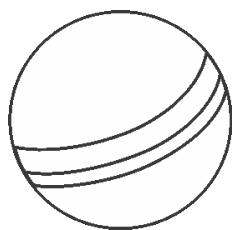
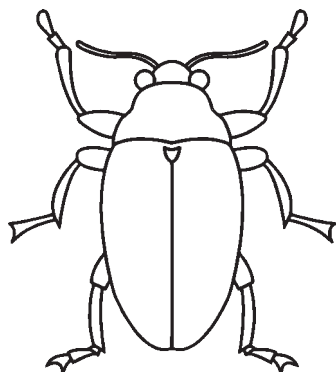
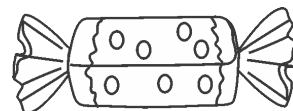
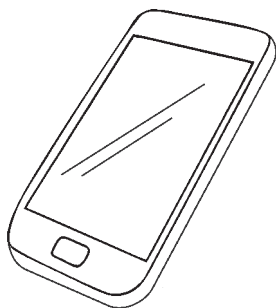
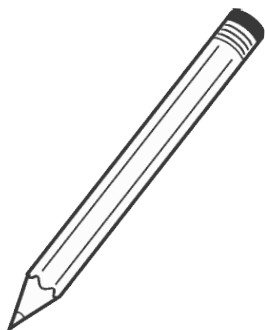
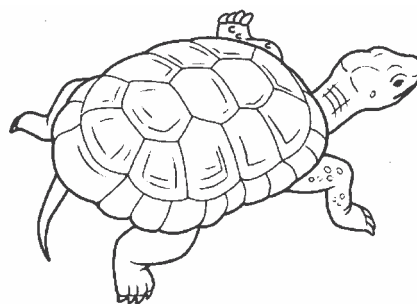
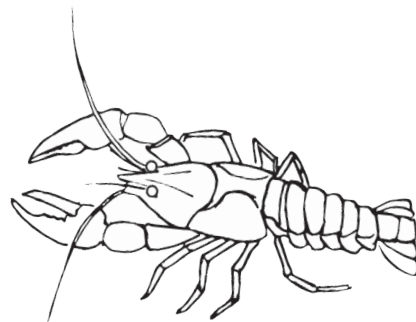
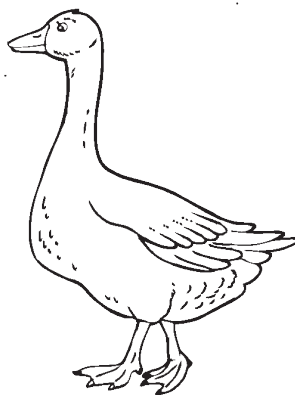
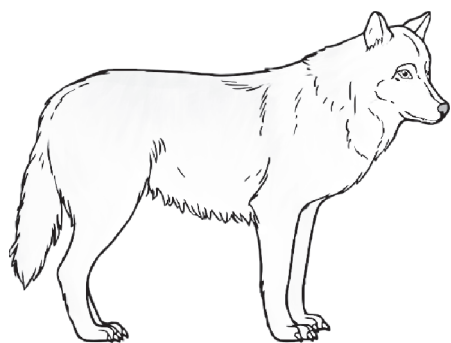
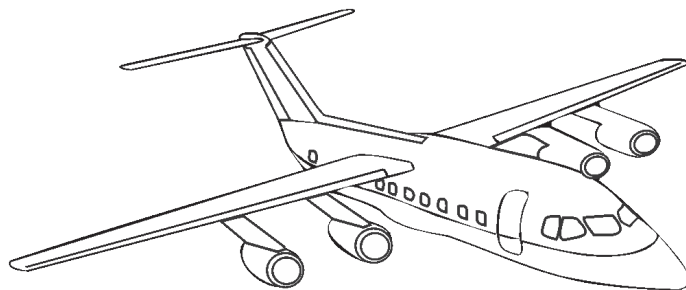
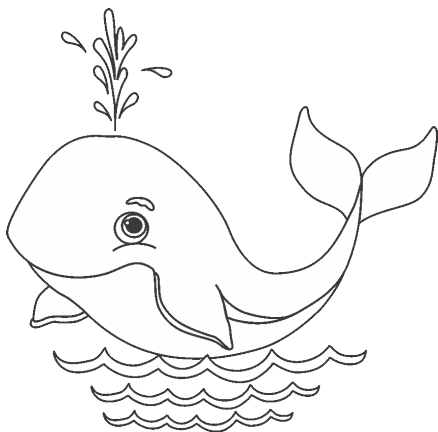

# ЗАНЯТКИ 2

1

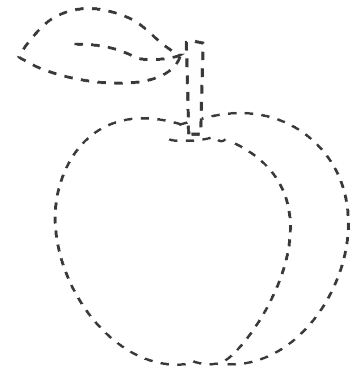
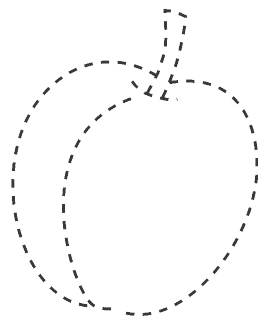
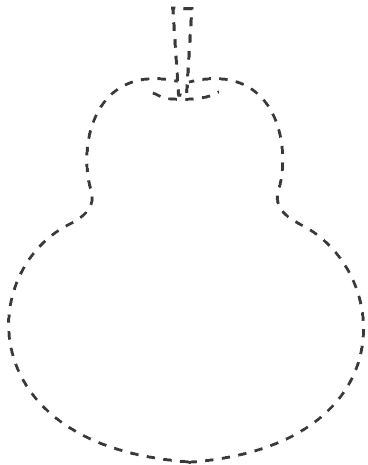
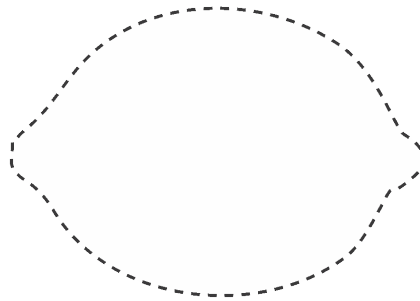
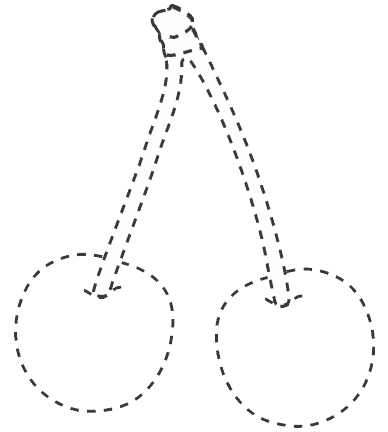
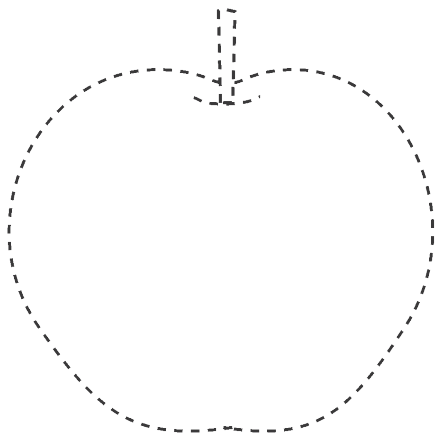

2



A large empty rectangular box for drawing.



## \*ЗАНЯТКИ 2

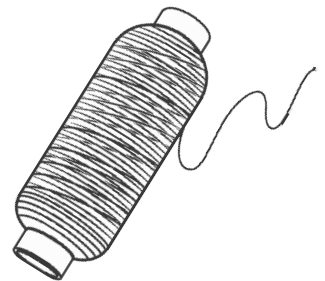
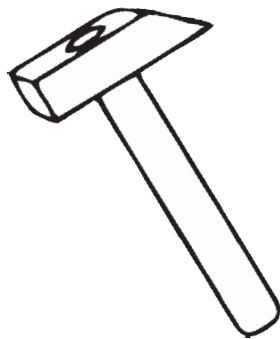
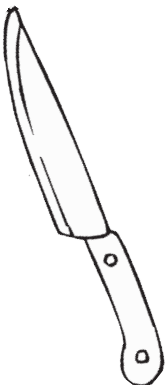
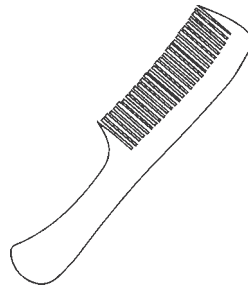
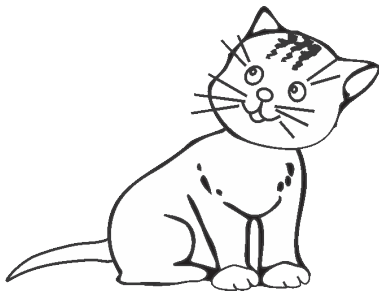
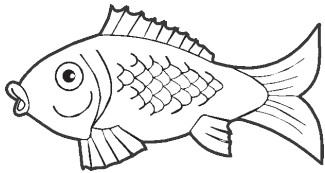
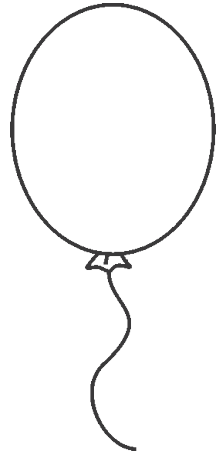
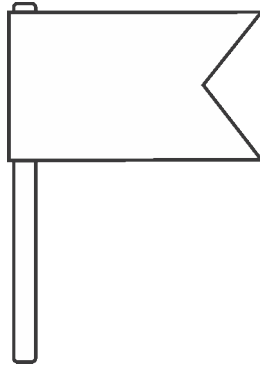
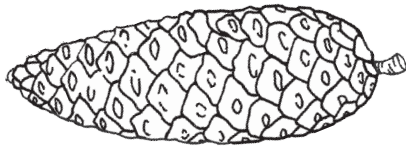
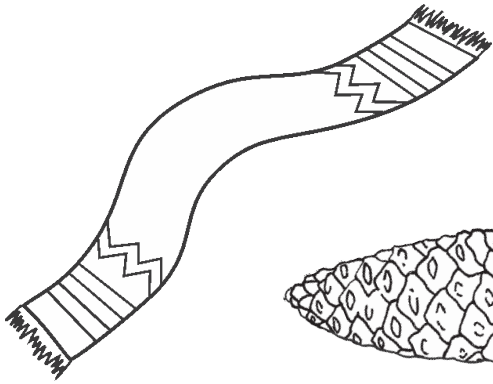

# ЗАНЯТКИ 3

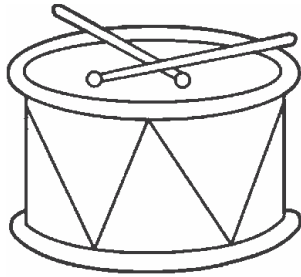

--	--	--



--	--

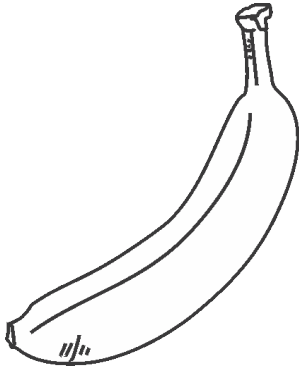

--	--

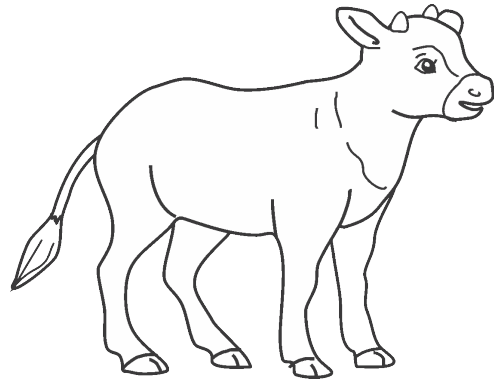

--	--

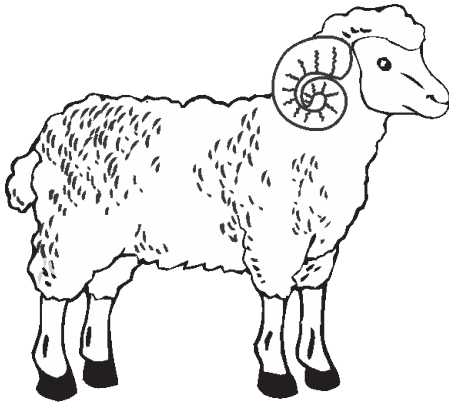

--	--



--	--

# \*ЗАНЯТКИ 3

1

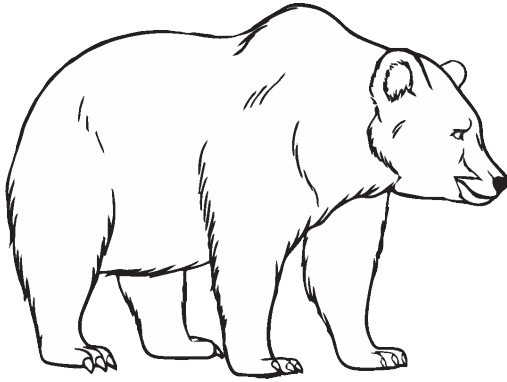

2

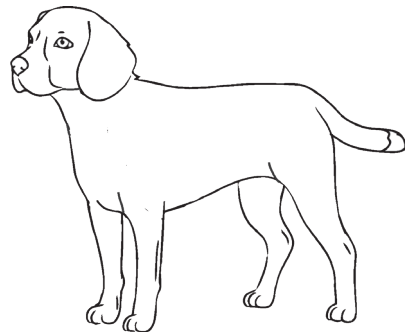
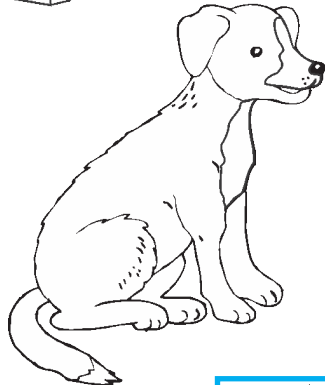
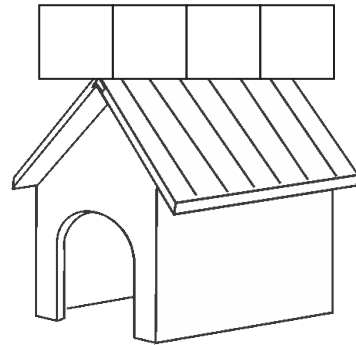
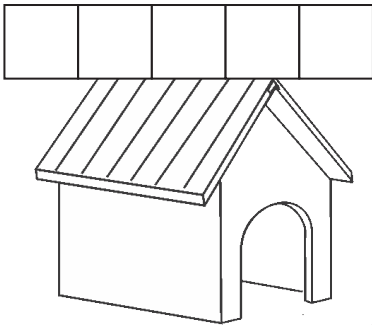

# ЗАНЯТКИ 4

1

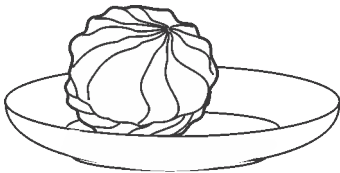
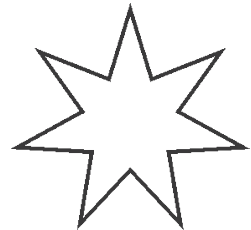
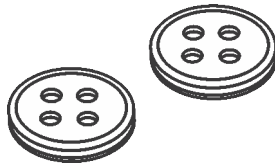
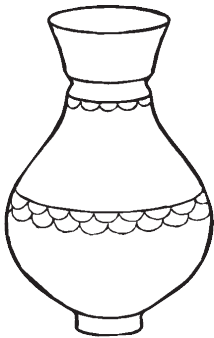
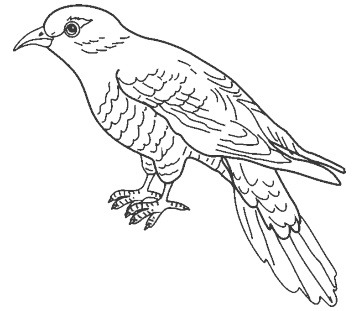
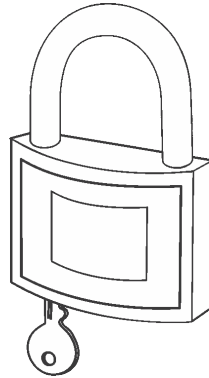

2

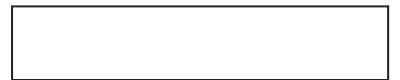
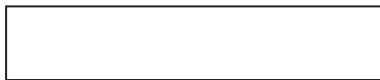
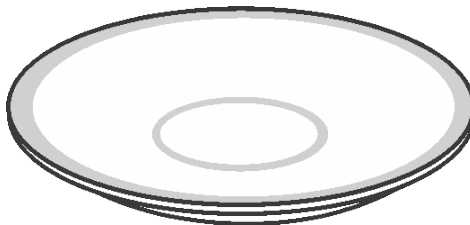
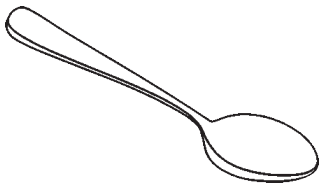

# \*ЗАНЯТКІ 4

1

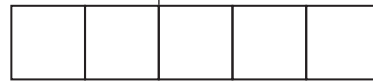
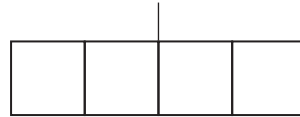
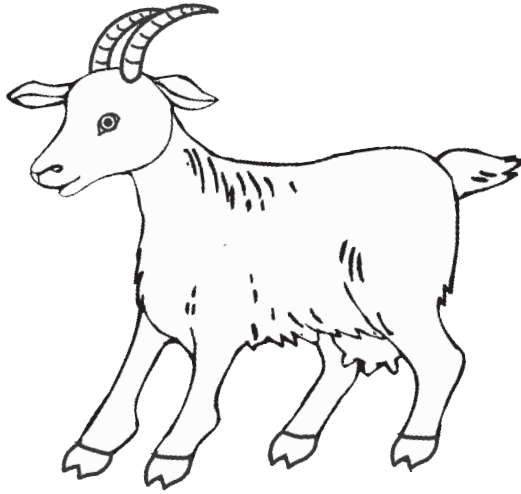
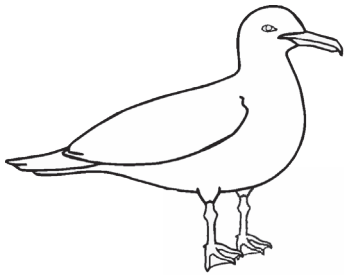

2

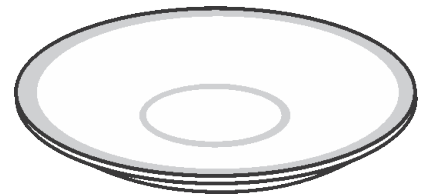
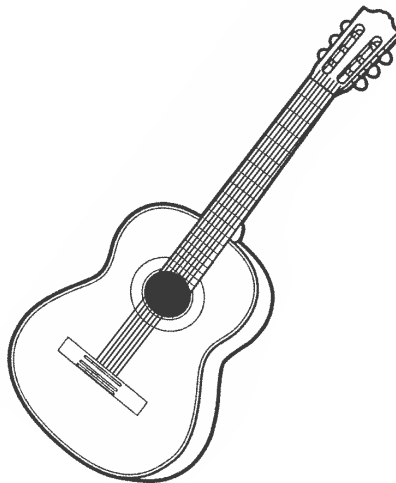
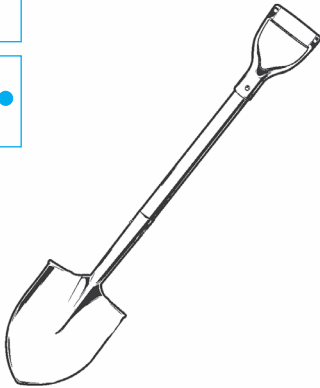
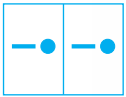

## ЗАНЯТКІ 6



--	--	--

\*ЗАНЯТКІ 6

1



Aa



A-a-a-a!

2

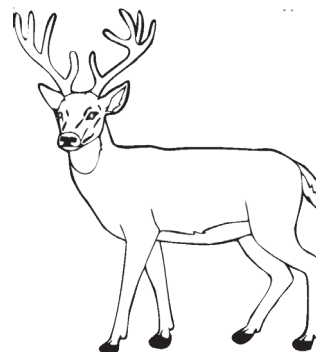

a a

a a

a

3

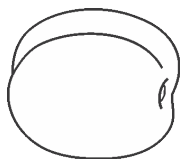

a

a

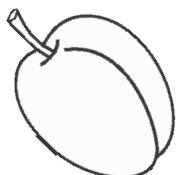
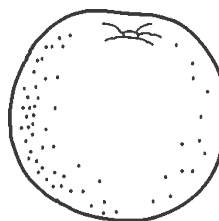

a a

a

# ЗАНЯТКИ 7

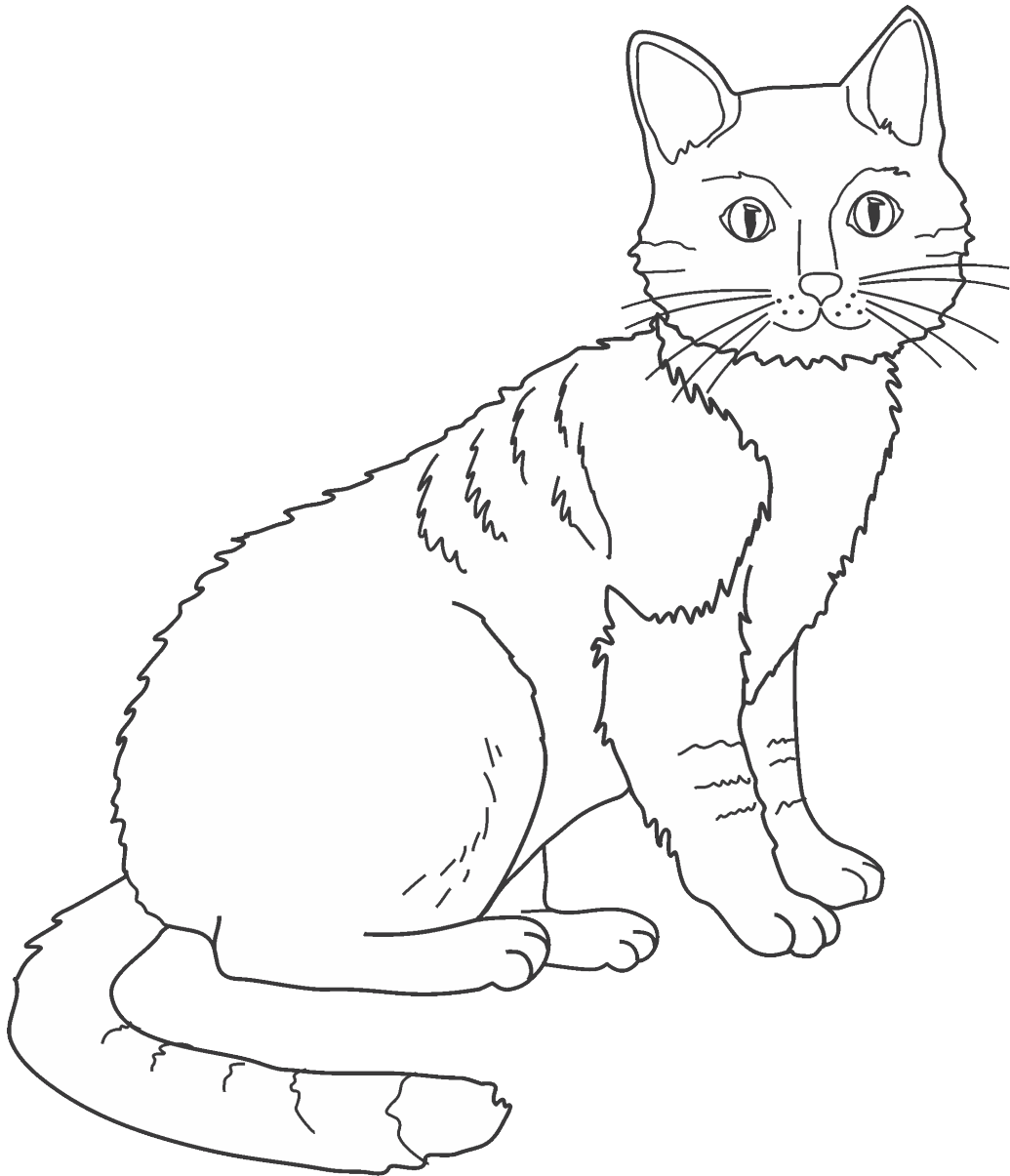

--	--	--



# \*ЗАНЯТКІ 7

1



# O o

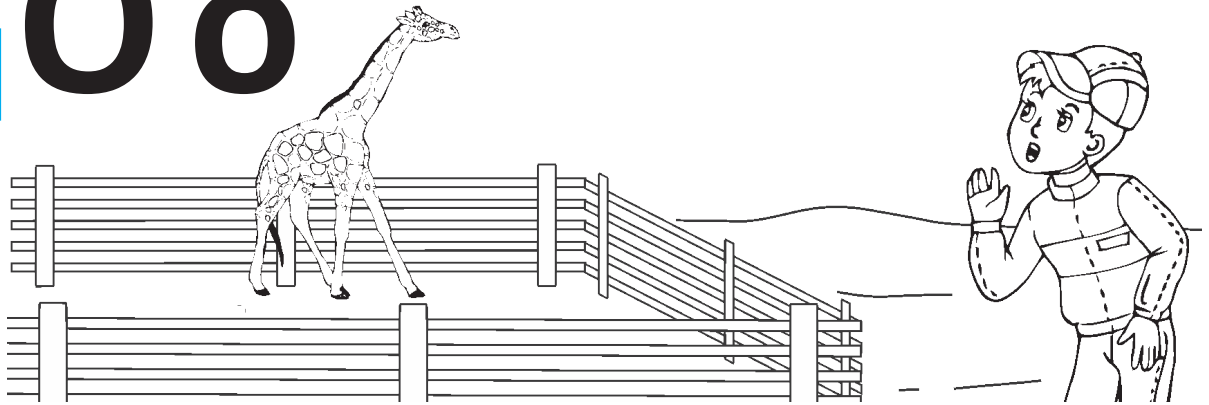

O-o-o-o!

2

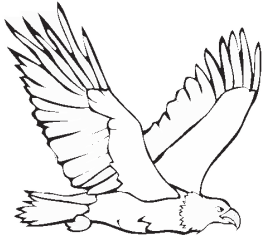
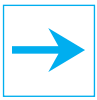

a

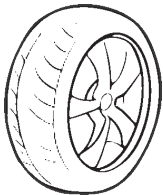

a o

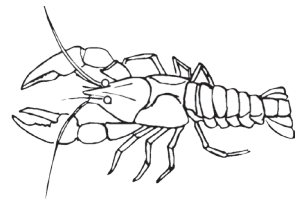

a

o a

o

3

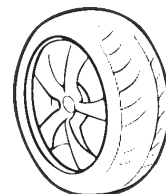
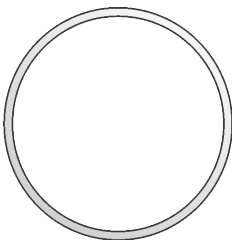
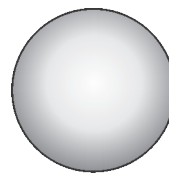
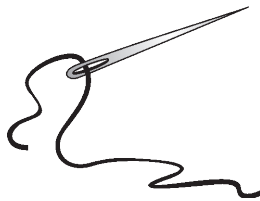
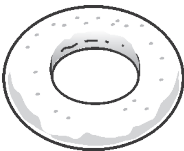

## ЗАНЯТКИ 8

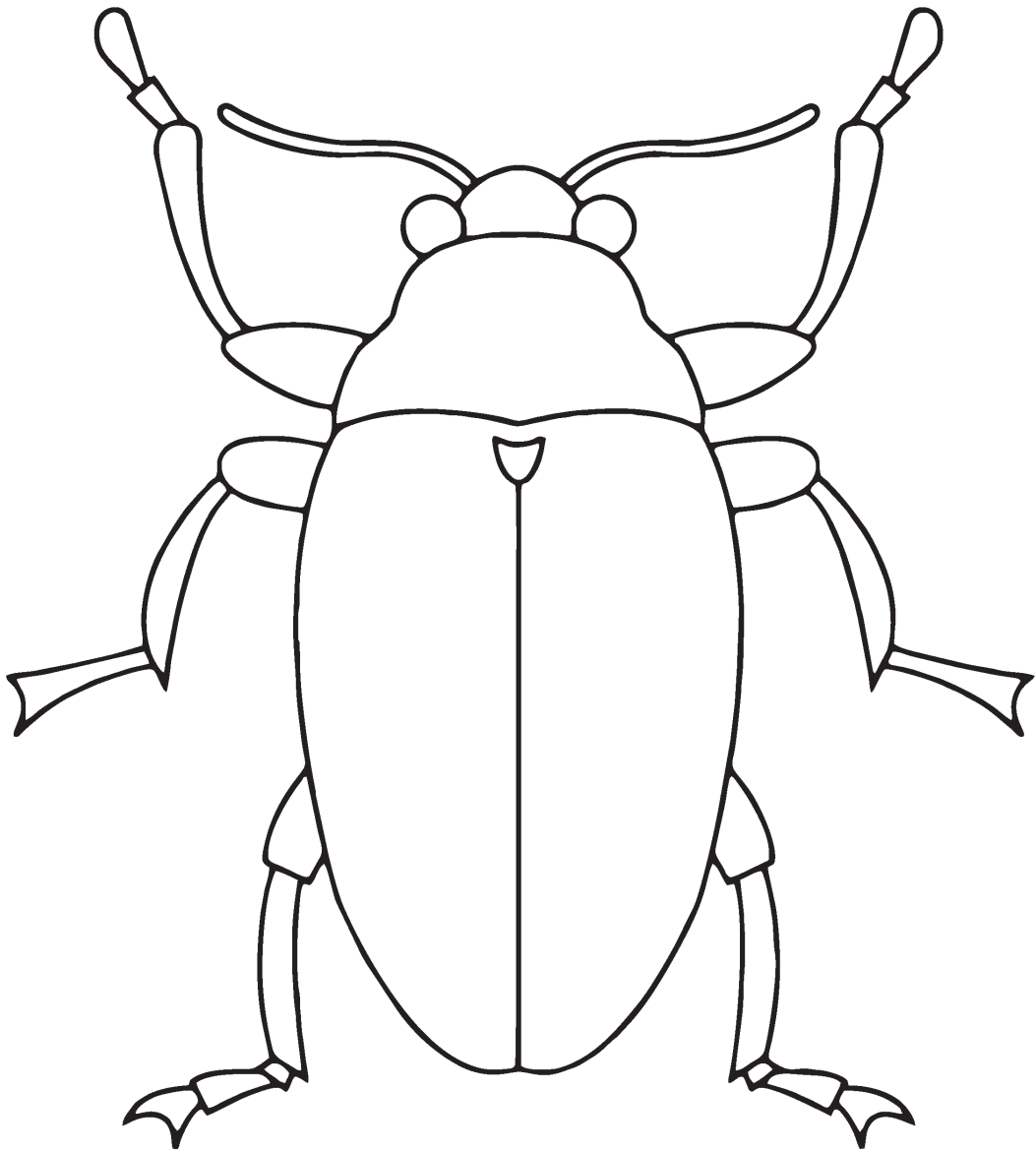

\*ЗАНЯТКІ 8

1



у у

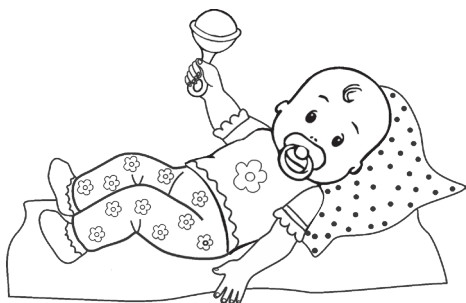

Уа-уа.



Ау-у-у-у!

2



А

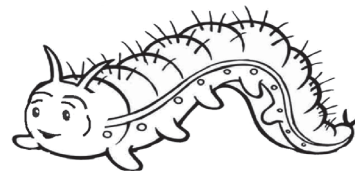
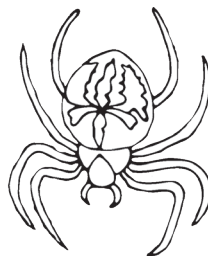
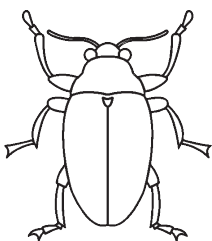

--	--	--	--	--

--	--	--	--

--	--	--	--	--	--

--	--	--	--	--

3



	а			а
--	---	--	--	---

а		о	
---	--	---	--

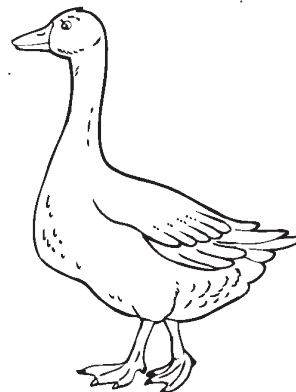
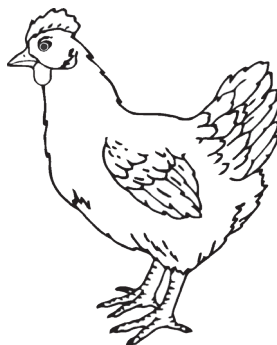
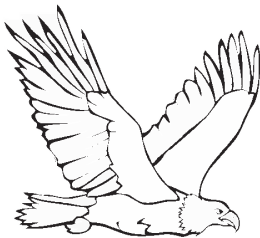
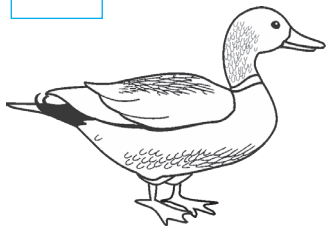

	у				а
--	---	--	--	--	---

	у	
--	---	--

# ЗАНЯТКИ 9

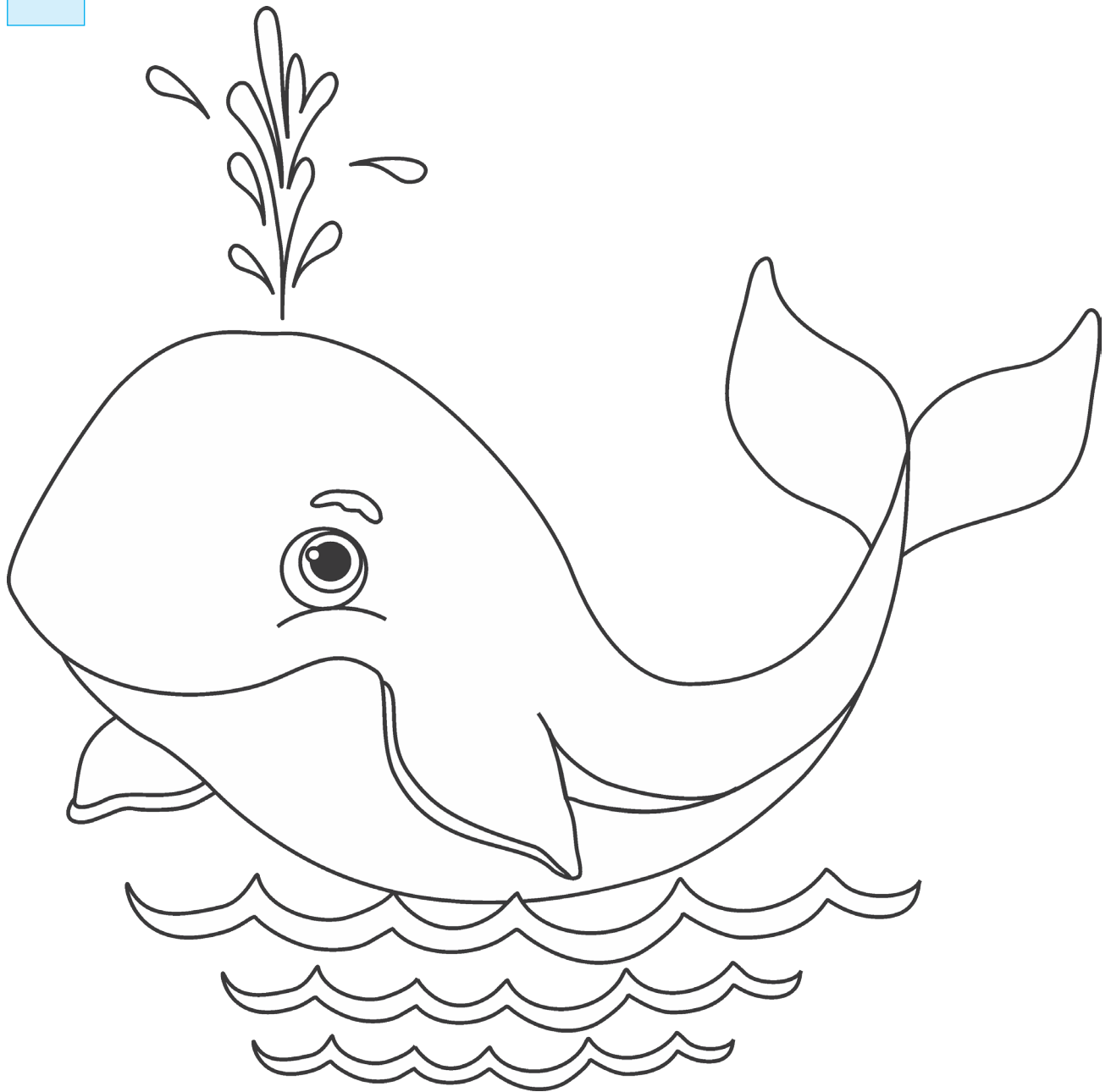

--	--	--

# \*ЗАНЯТКІ 9

1



l i

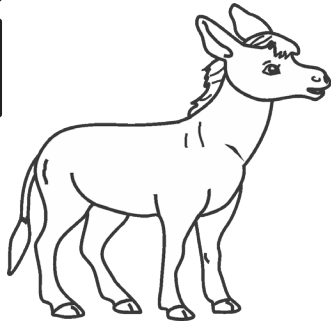

la! la! la!

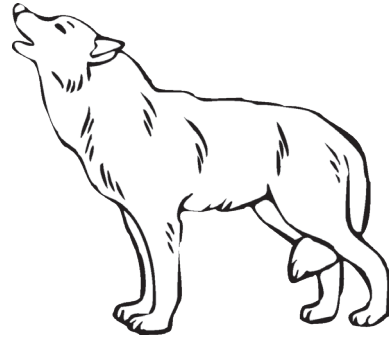

У-y-y-y!

2

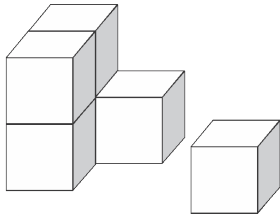

□ i □ □ a

□ y □ i □ i

□ a □ □ o □

□ a □ □ a



3

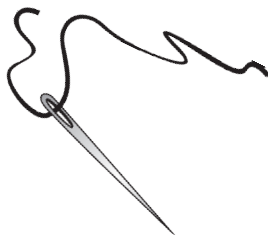

□ □ □ □ □ □



4



A I O Y I I Y

O A I Y A O I

# ЗАНЯТКІ 9

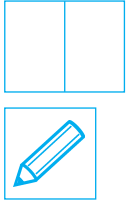

--	--	--

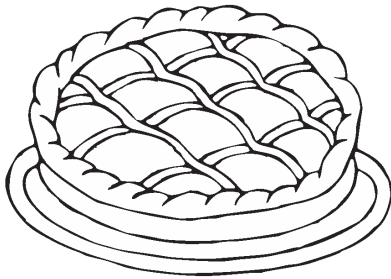
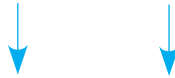

--	--



--	--



# ЗАНЯТКИ 10

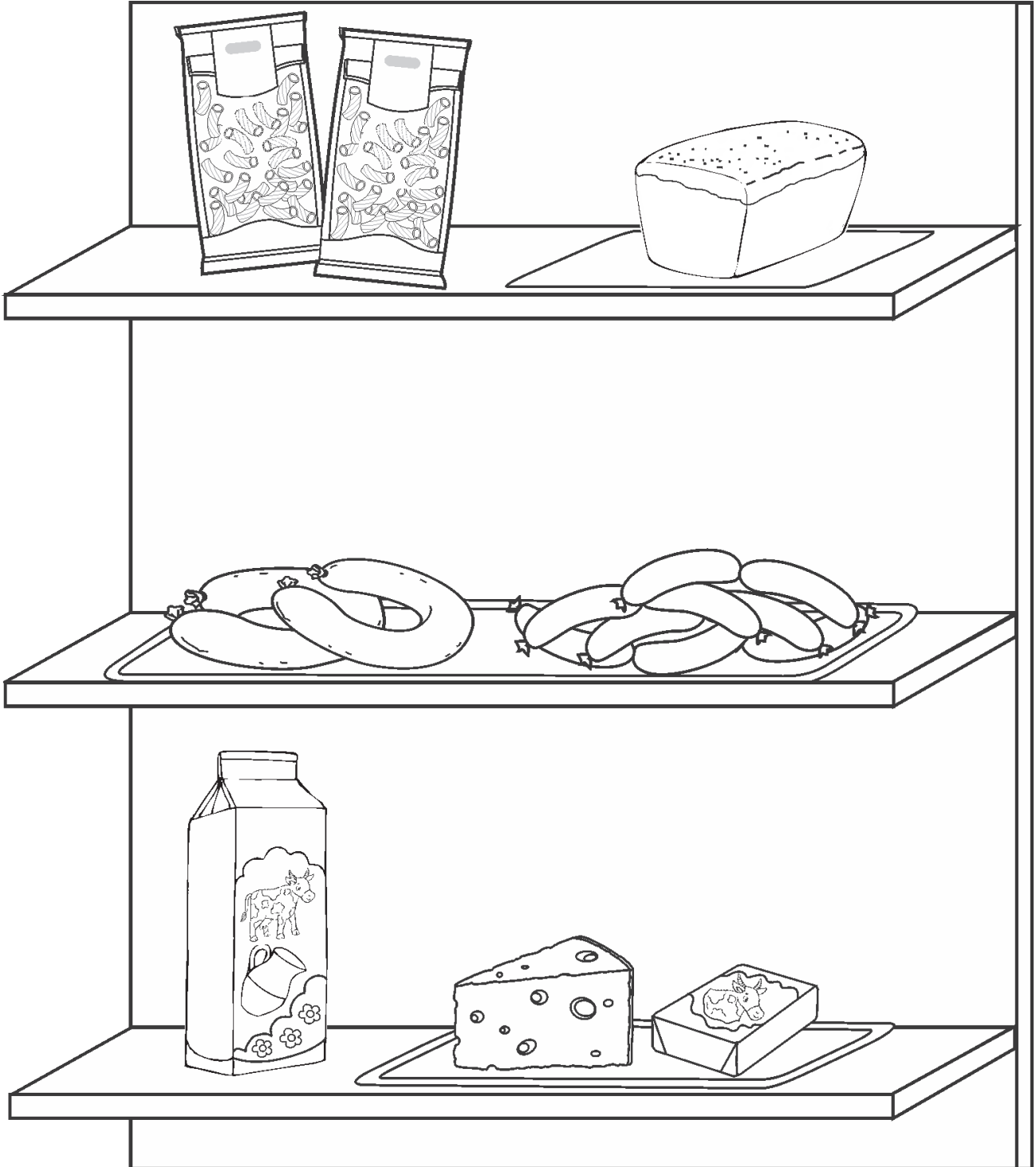

# ЗАНЯТКИ 10

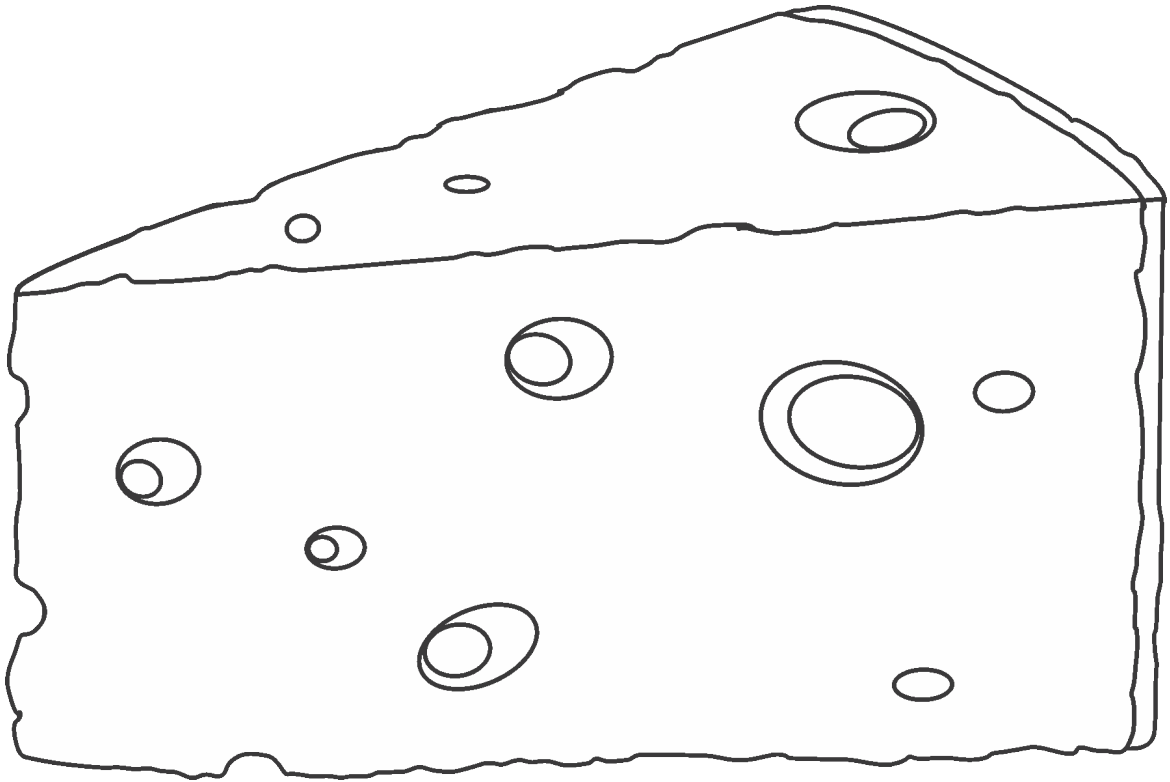



\*ЗАНЯТКИ 10



# Ы Ы

ы і

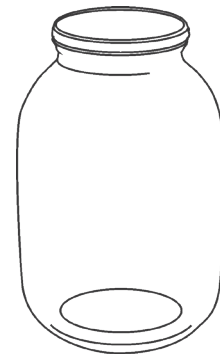
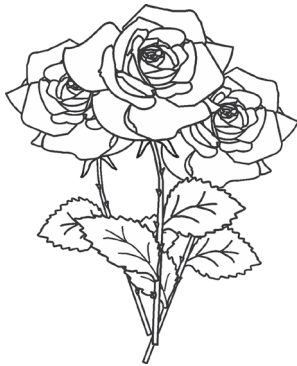

ы і

		о		
--	--	---	--	--

ы і

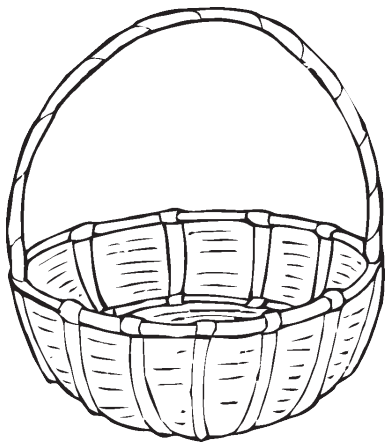

	у		
--	---	--	--

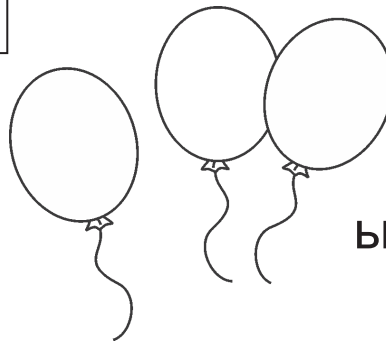

ы і

	о			
--	---	--	--	--

	а		
--	---	--	--

ы і

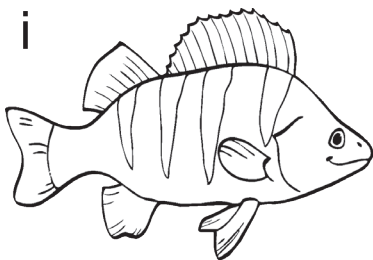

			а
--	--	--	---

ы і

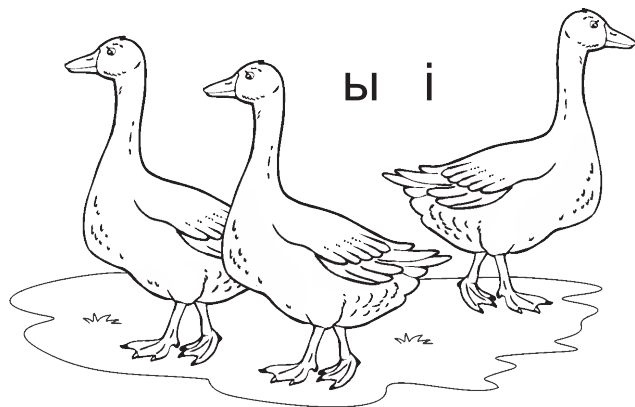

	у		
--	---	--	--

# ЗАНЯТКИ 11



--	--	--

# \*ЗАНЯТКИ 11

1 Э э

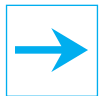

э



ы

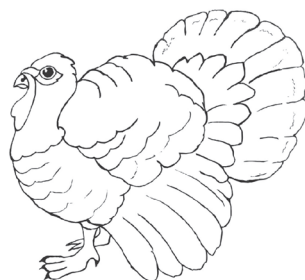

у



а

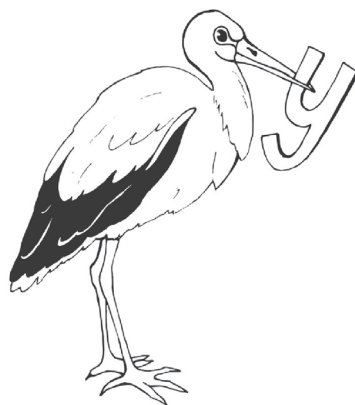

і



2

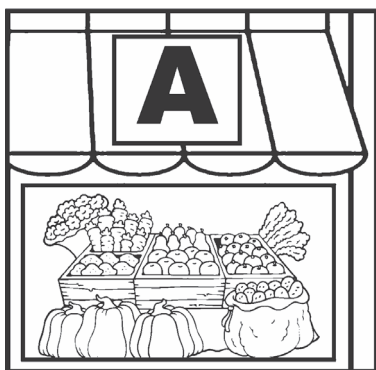

3



Э

+

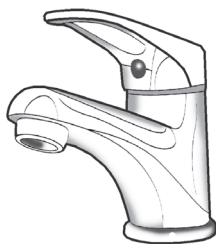

э       а

# ЗАНЯТКИ 11

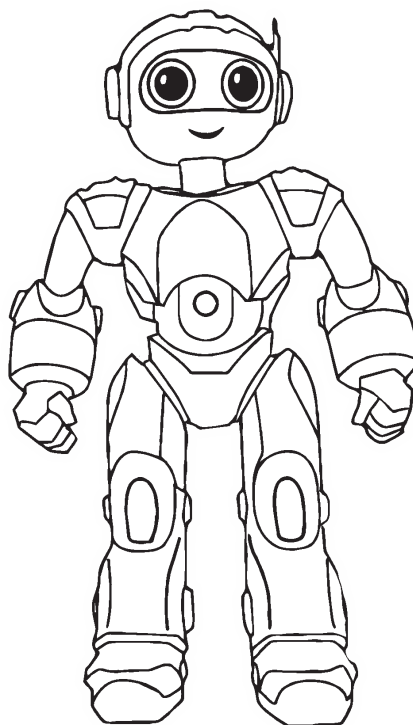
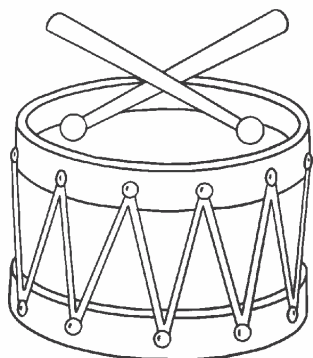
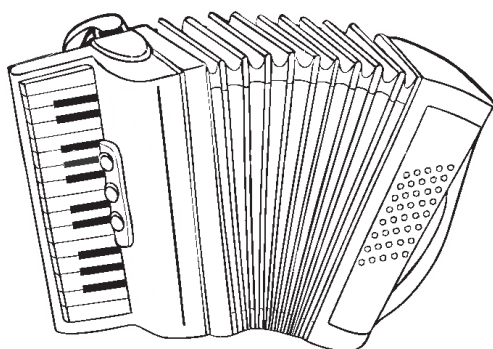
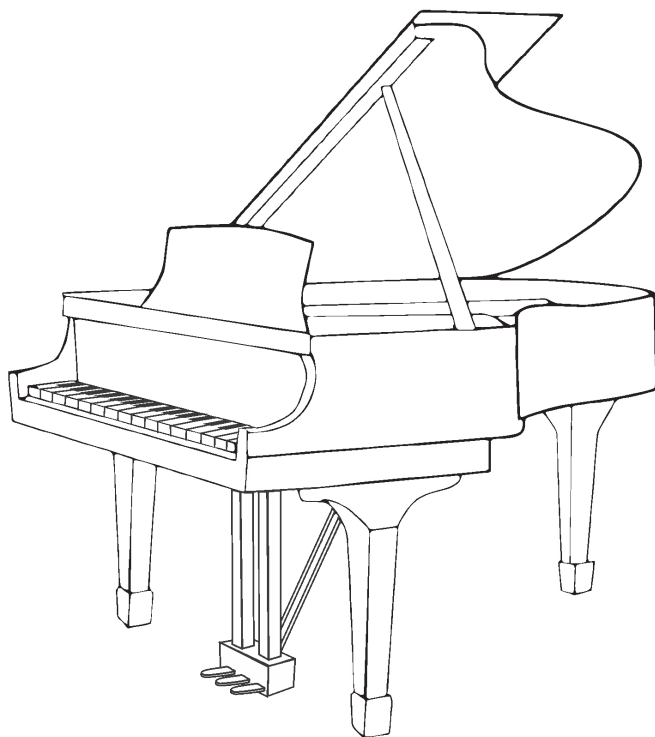
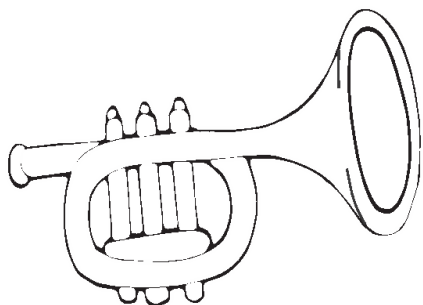

# ЗАНЯТКИ 12



--	--	--

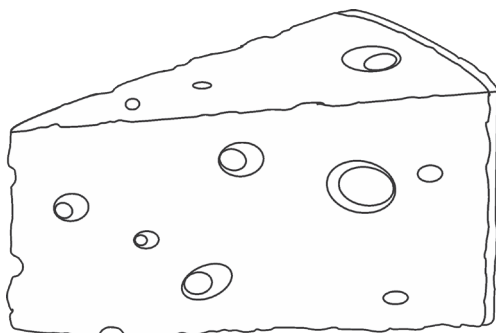

--	--	--

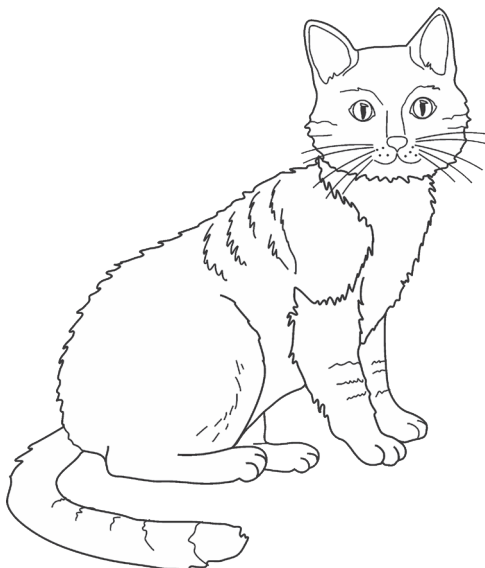

--	--	--

# ЗАНЯТКИ 12

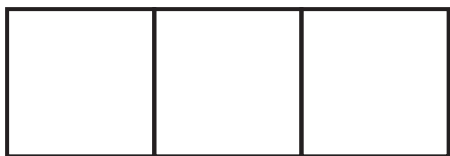
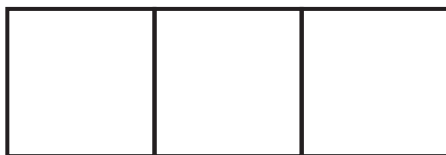
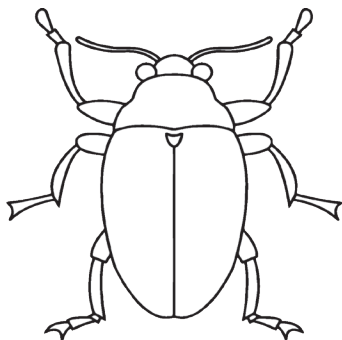
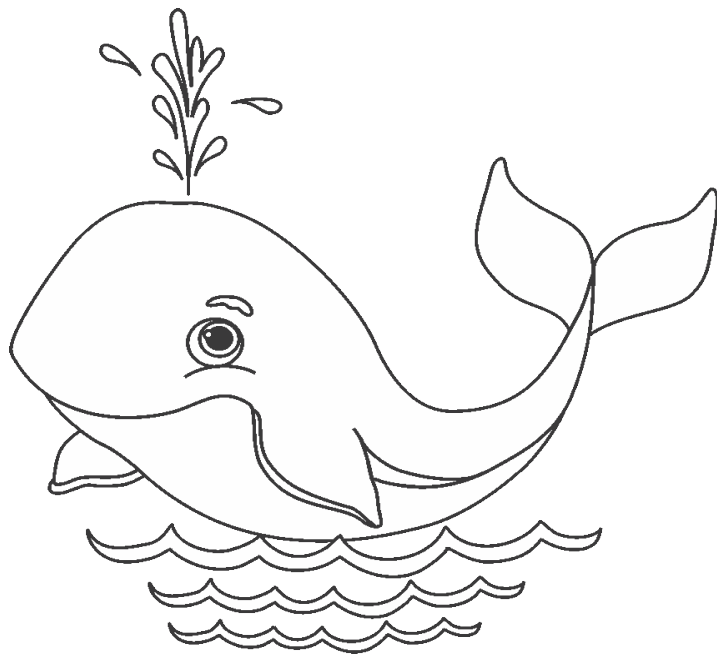
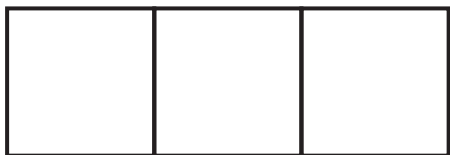

# \*ЗАНЯТКИ 12

1



А а

У у

О о

Ы

І і

Э э

2



э		у
---	--	---

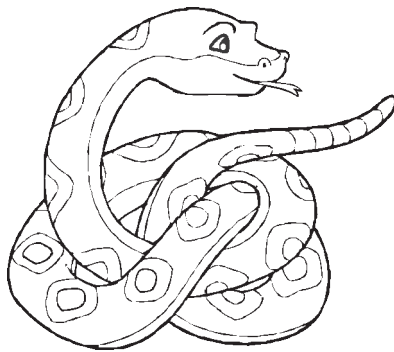
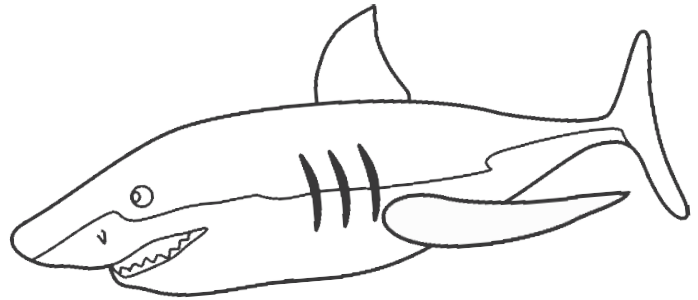

а			
---	--	--	--



у		а	
---	--	---	--

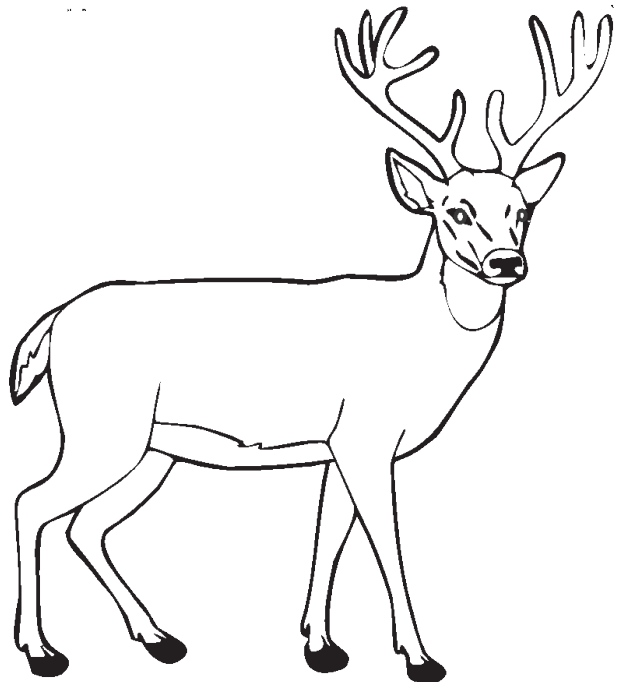

а		у		а
---	--	---	--	---

## ЗАНЯТКІ 13

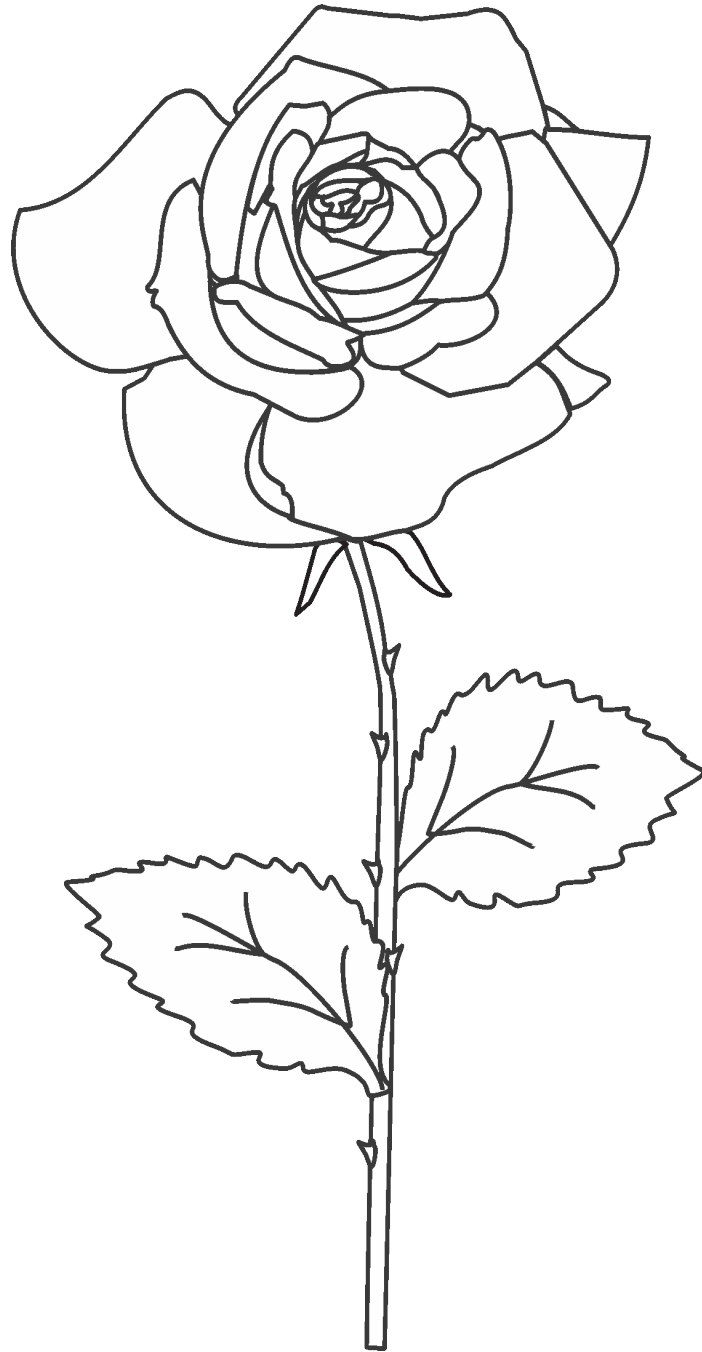

--	--	--	--



## \*ЗАНЯТКИ 13

1

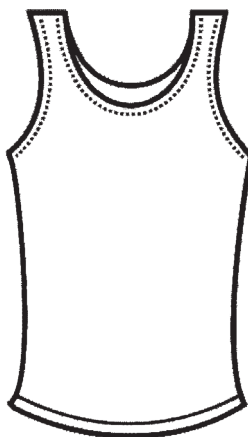
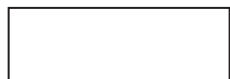

2

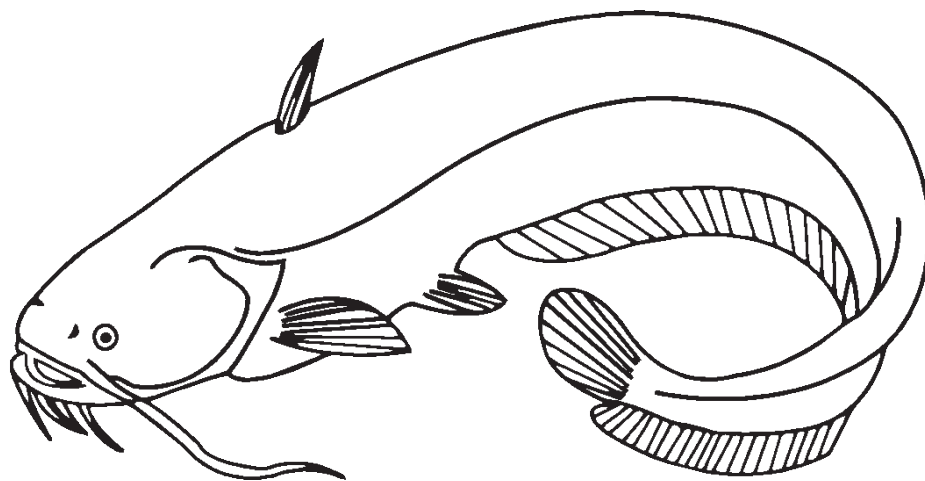
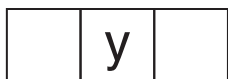
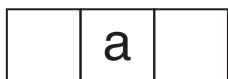

# ЗАНЯТКИ 13

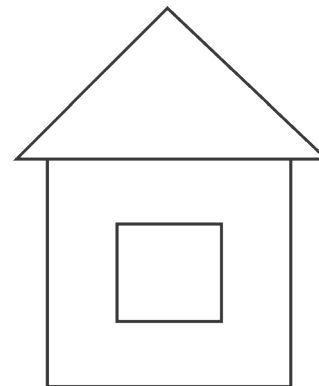
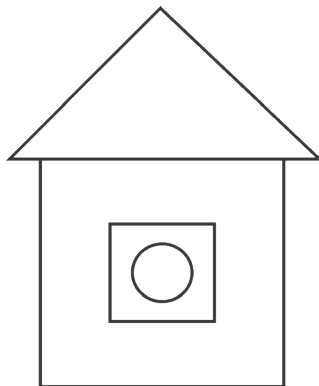
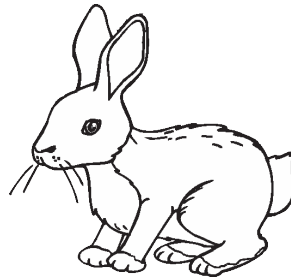
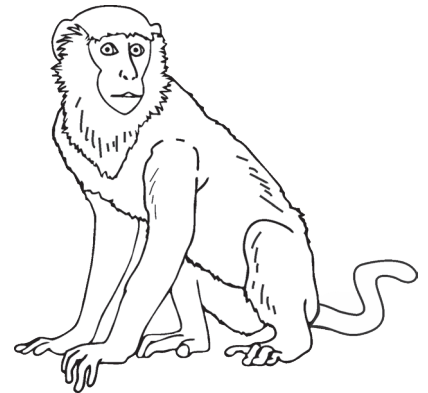
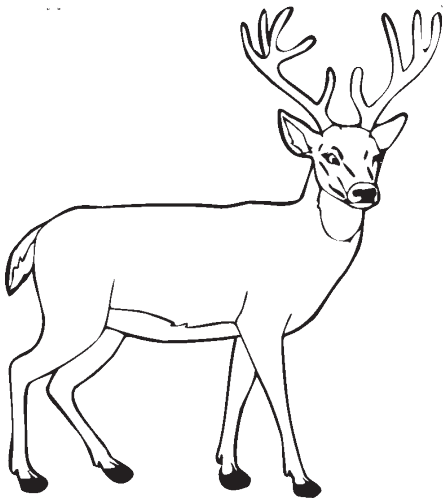
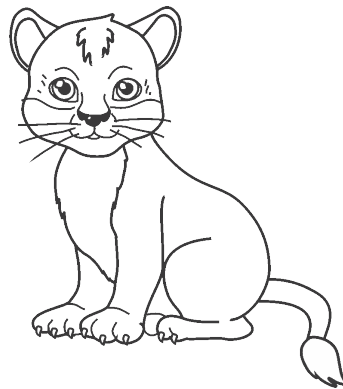
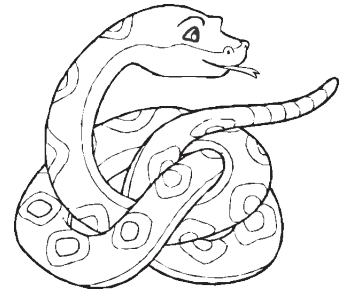
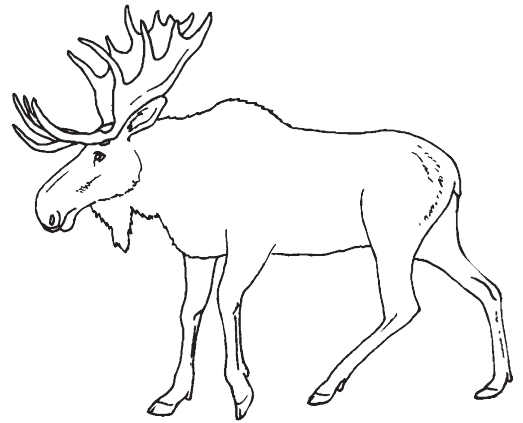
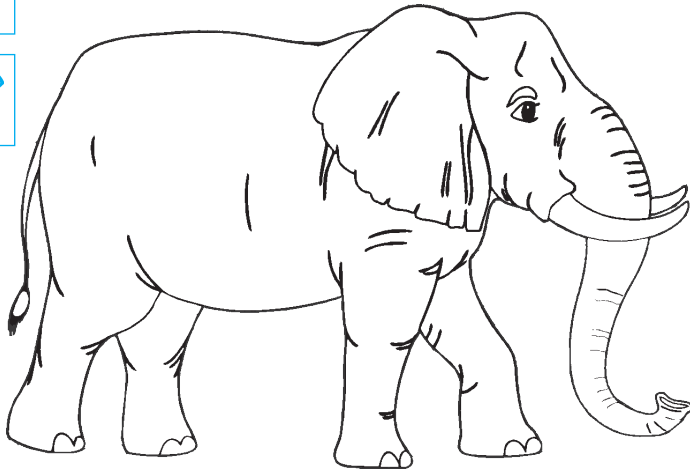

# ЗАНЯТКІ 14

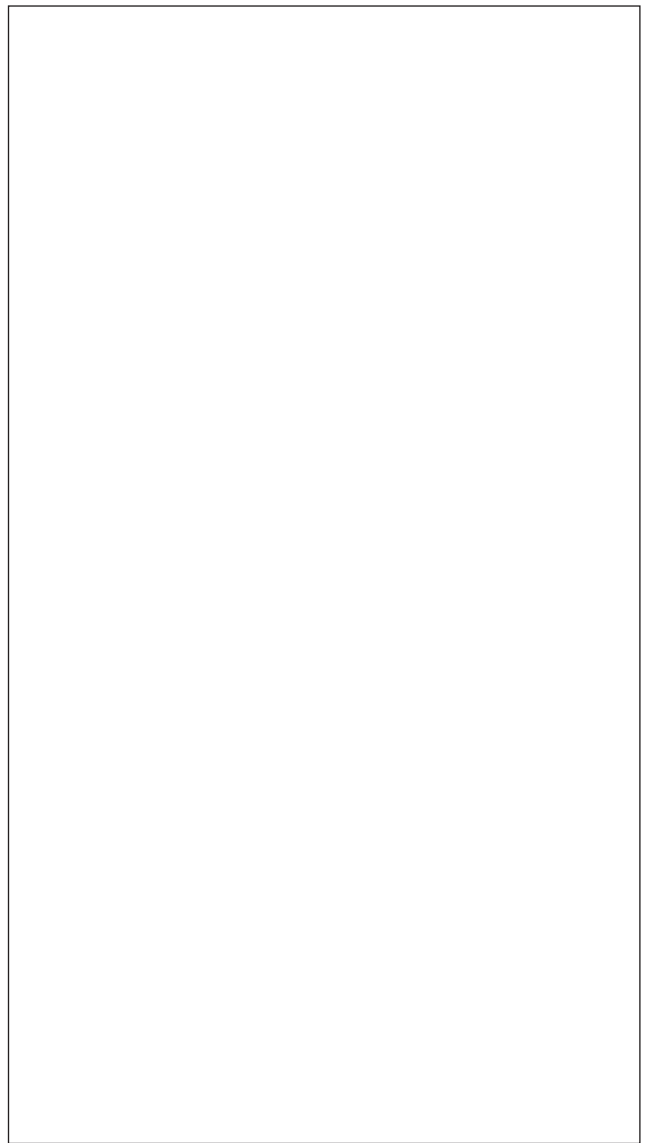
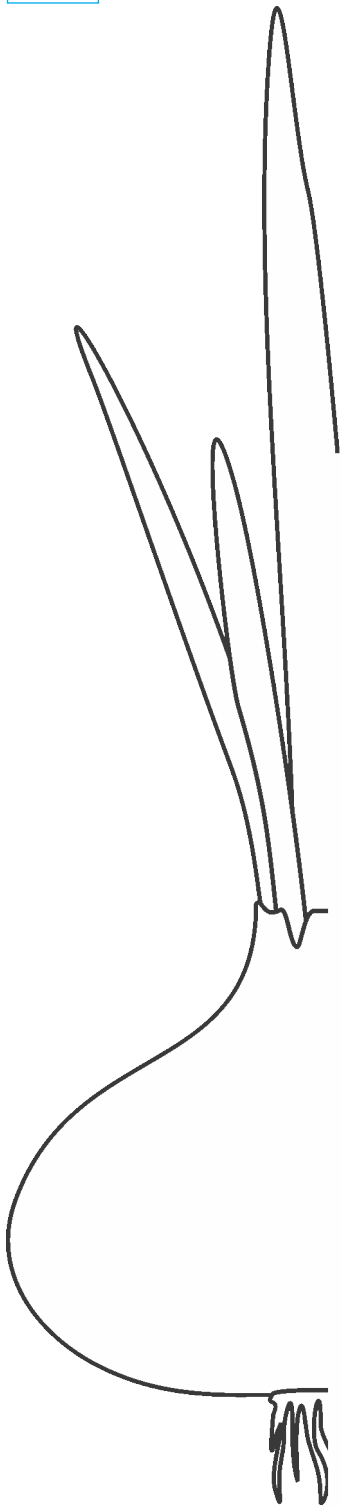
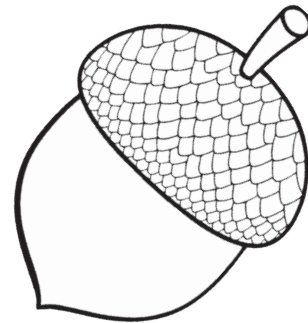

# ЗАНЯТКИ 14

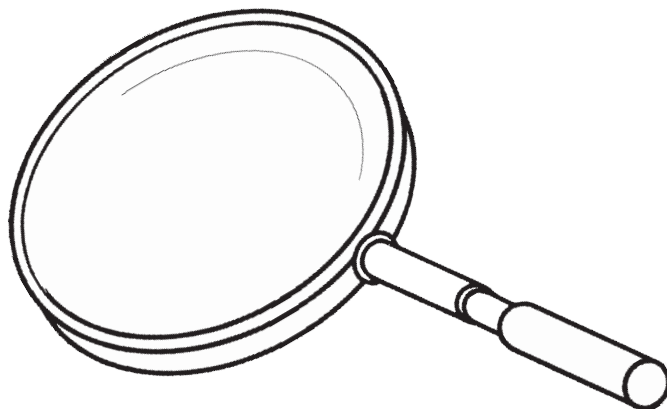

--	--	--	--

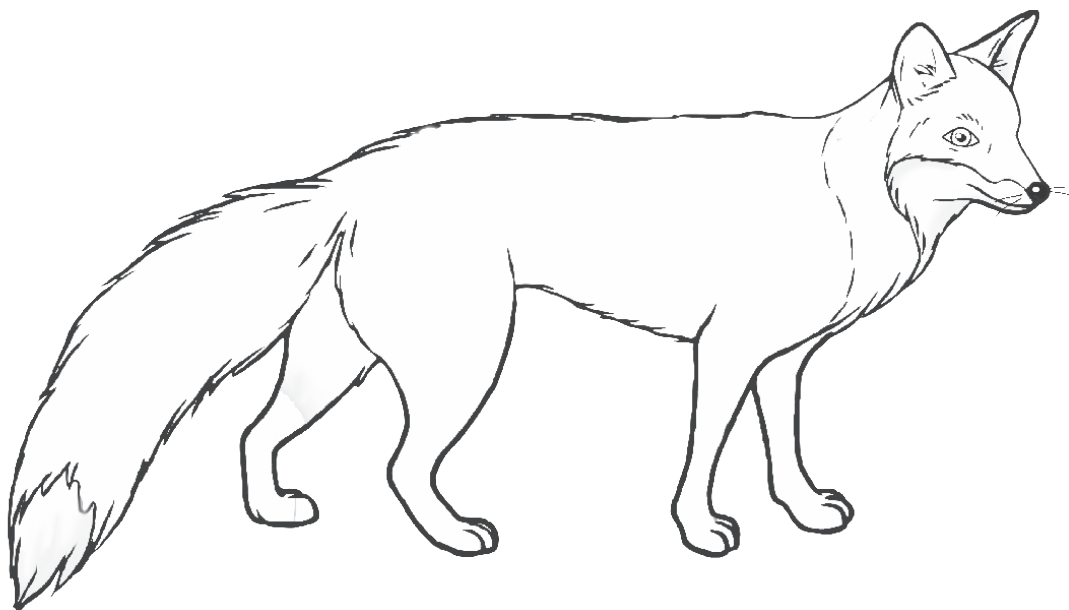

--	--	--	--

# \*ЗАНЯТКИ 14

1

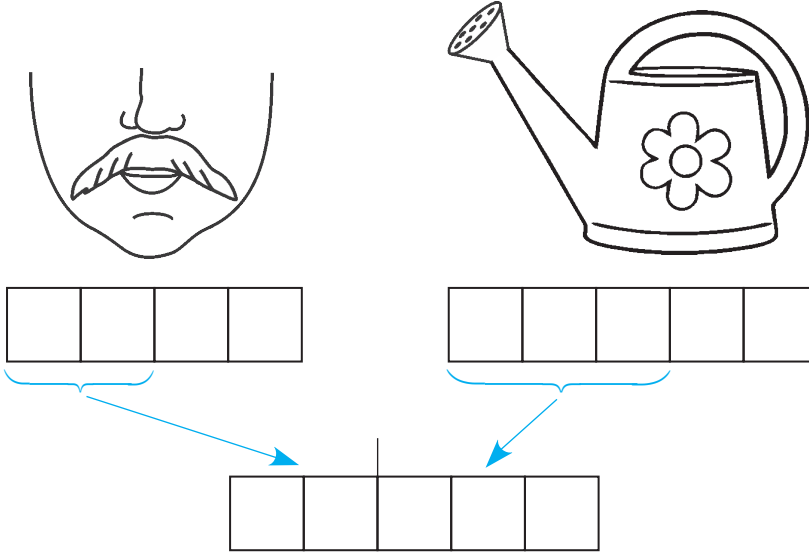

2



А

У

Ы



3



Ы А У Э У У О І У

## ЗАНЯТКИ 15

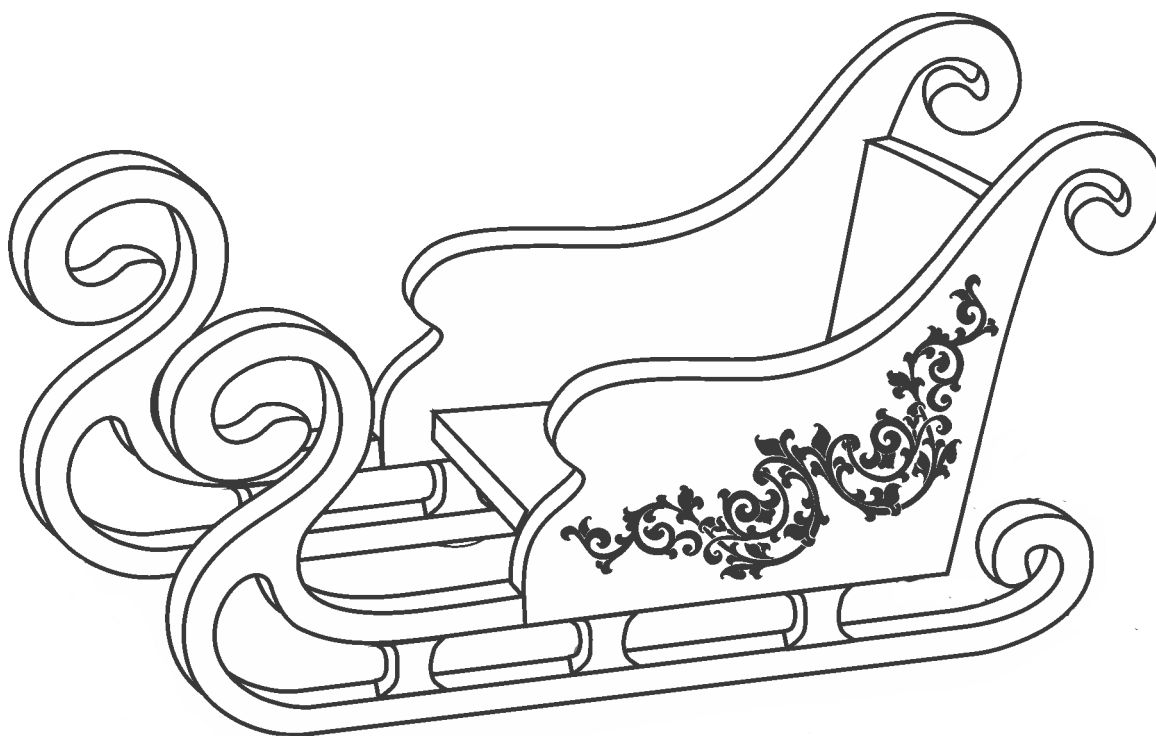

# \*ЗАНЯТКИ 15

1

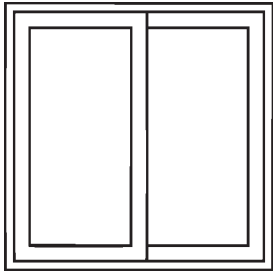

	a		a
--	---	--	---

↓

l		
---	--	--



	a		ы
--	---	--	---

↓

э		
---	--	--

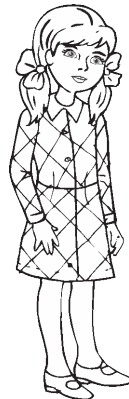

	a		ы
--	---	--	---

↓

A		
---	--	--



2



	a			a
--	---	--	--	---

	i			a
--	---	--	--	---

3



у А V < о €  
 ы Ъ l ы l э  
 о Ъ l ы l э

# ЗАНЯТКИ 16

1

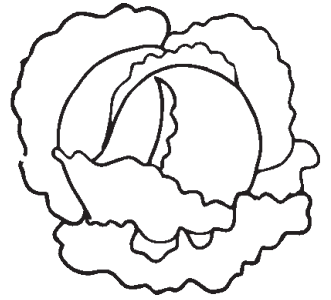
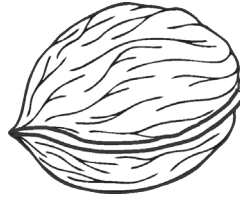
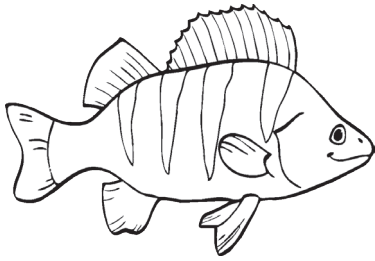

2

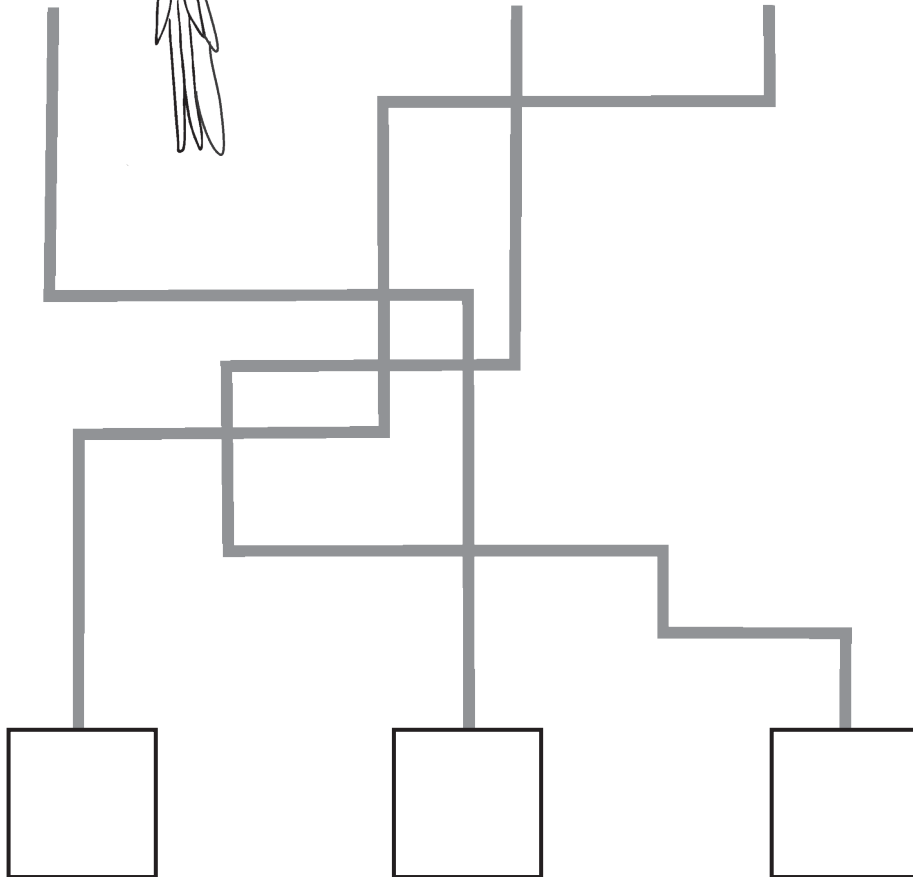
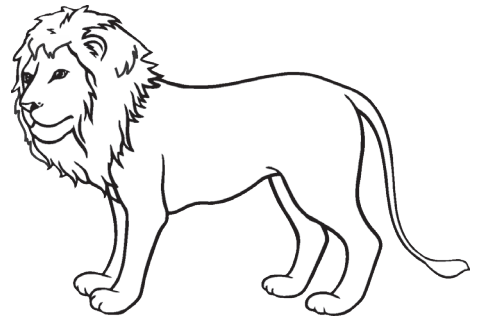
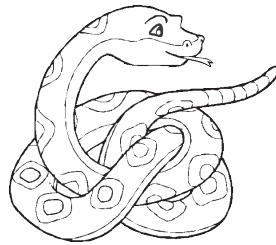



# \*ЗАНЯТКИ 16

1

--	--

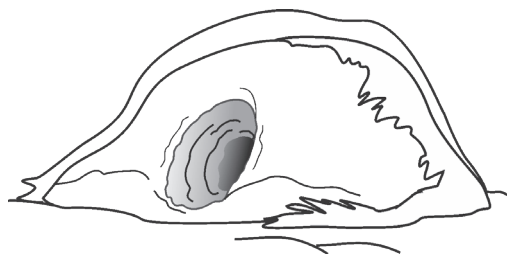



2

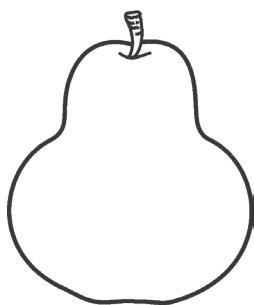

		у		а
--	--	---	--	---

		ы		а
--	--	---	--	---



3

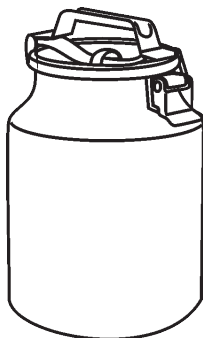

	а		о	
--	---	--	---	--

	і		о	
--	---	--	---	--

	у		о	
--	---	--	---	--

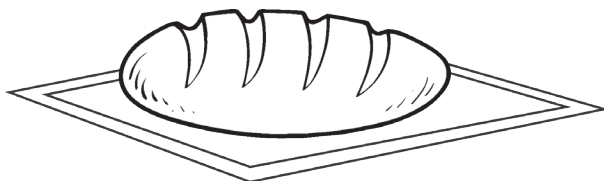
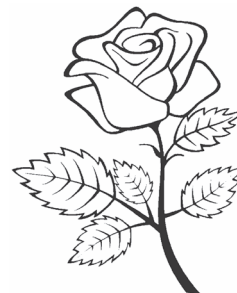

# ЗАНЯТКИ 17

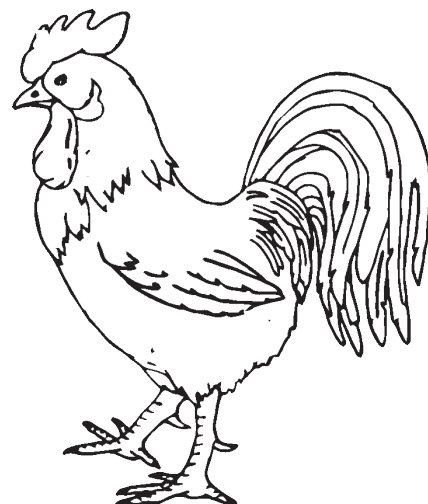
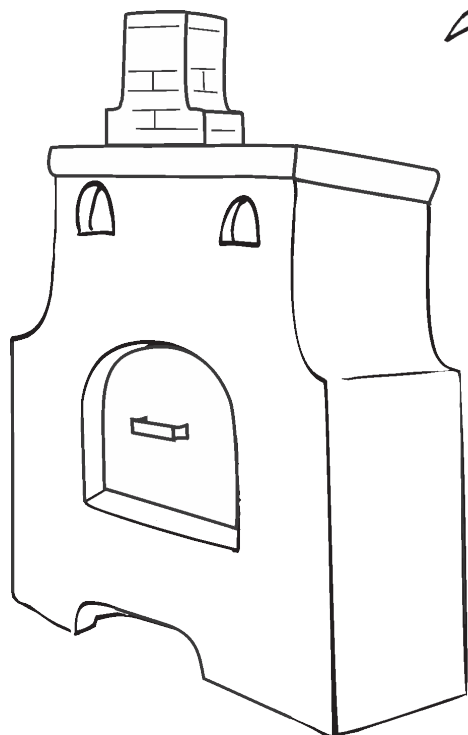
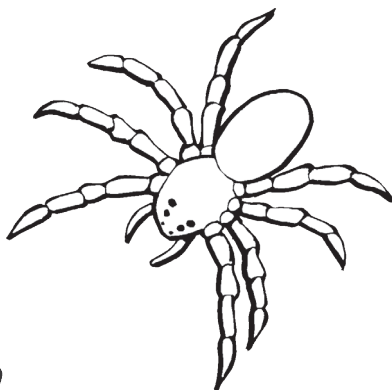
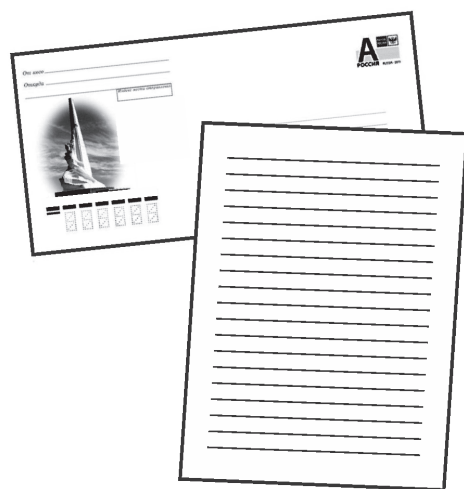
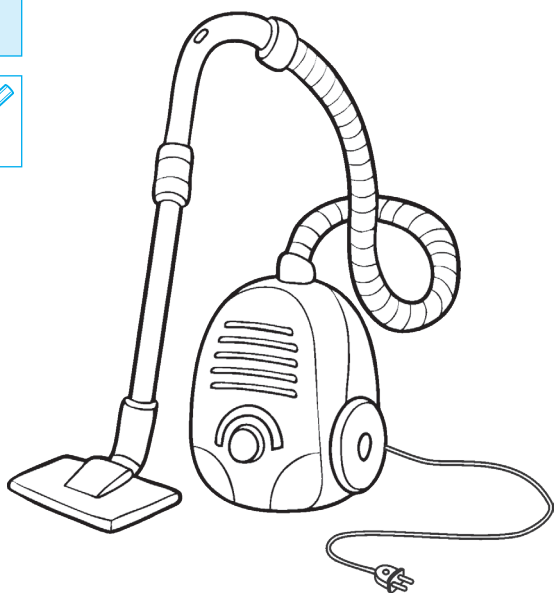

# \*ЗАНЯТКИ 17

1



□ ы □ □ а

□ і □ □ а

□ у □ □ а

□ о □ □ а

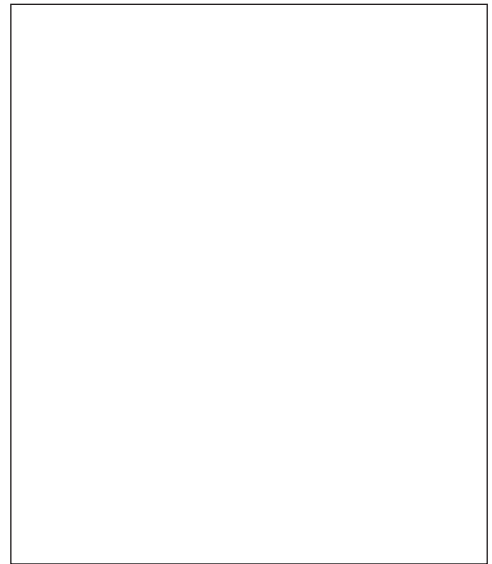
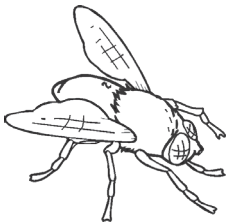

2

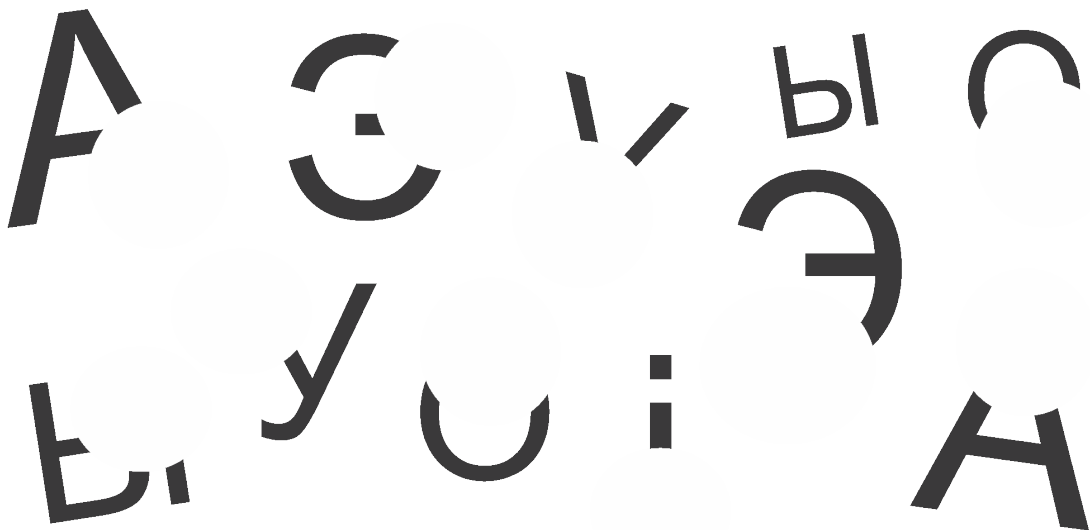

## ЗАНЯТКИ 18

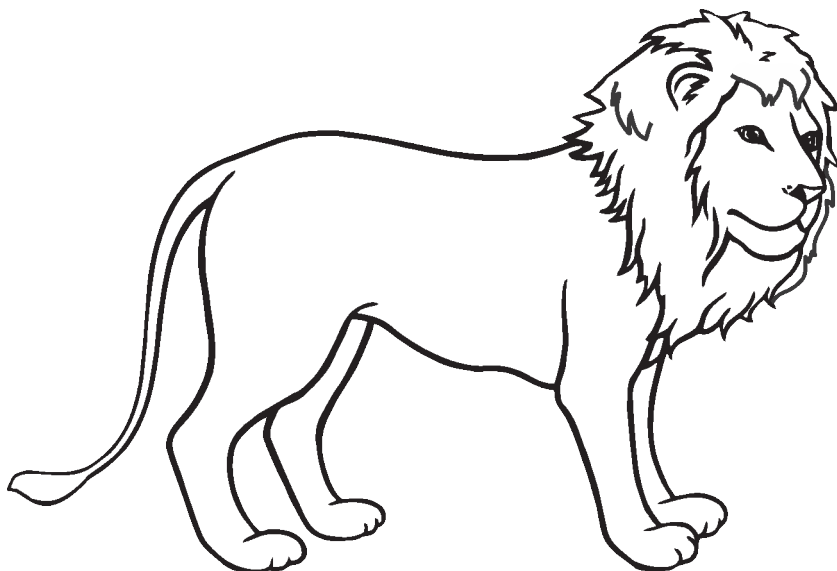
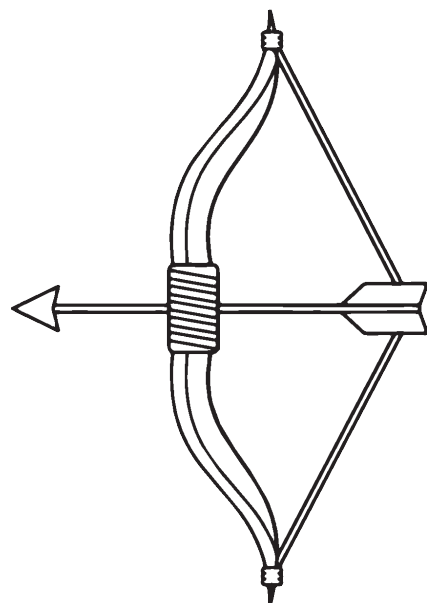
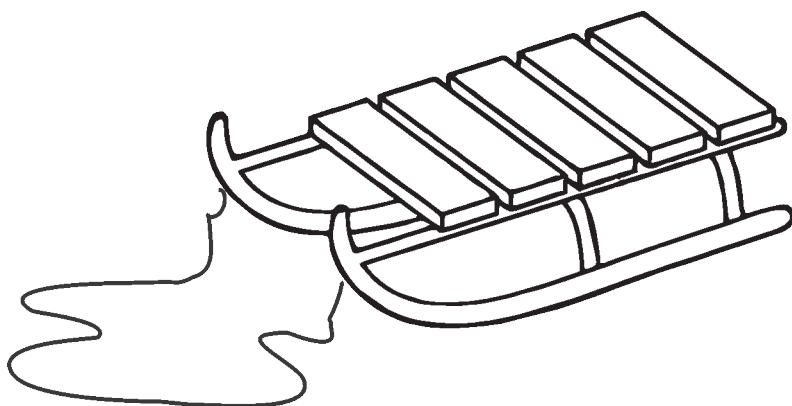
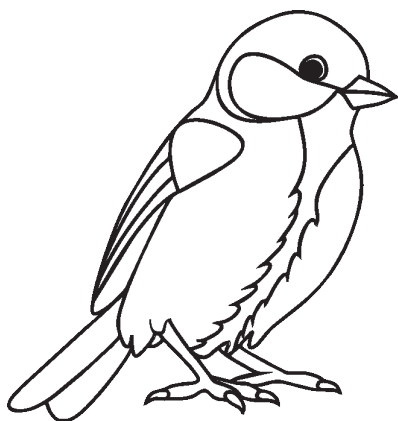

## \*ЗАНЯТКІ 18

1



# М м

ма мо му мі мы мэ  
мі му ма мо мэ мы

2

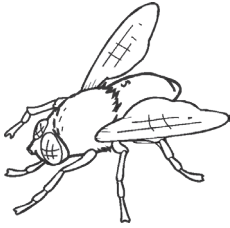

ма

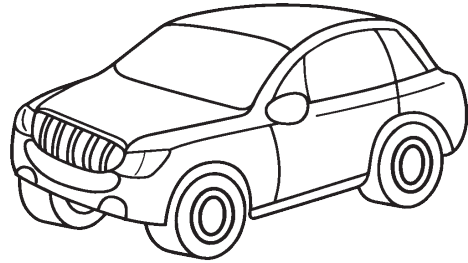

му



мо



мі



мы

3

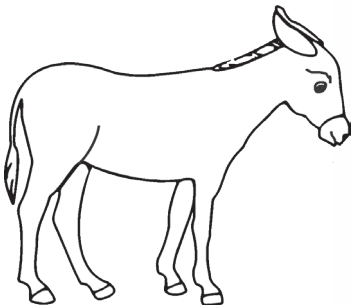

— la-la!

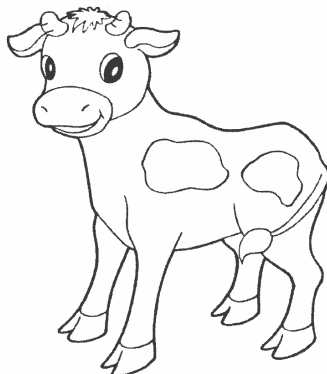

— Му-му!

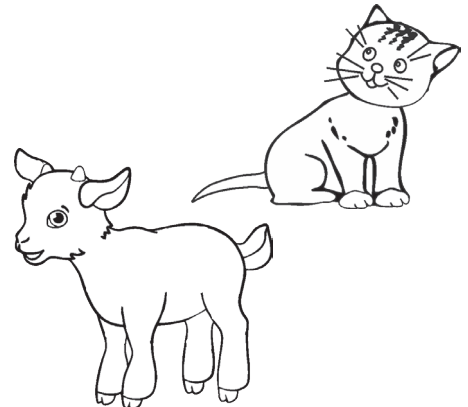

— Мэ-мэ!

# ЗАНЯТКИ 19

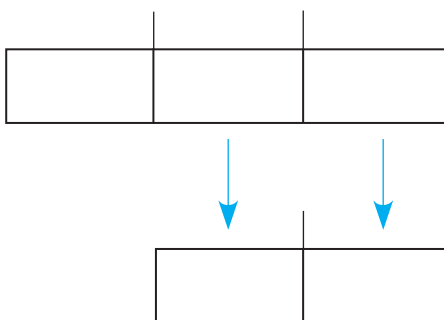
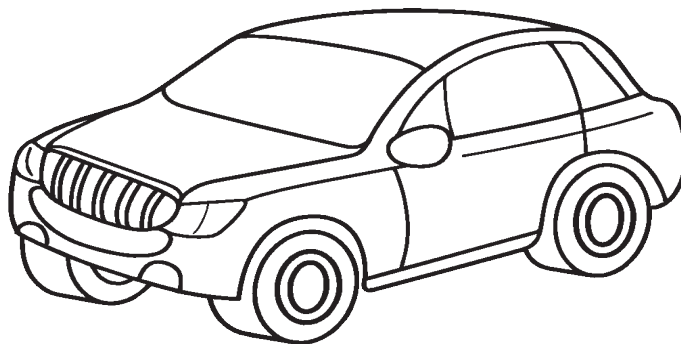
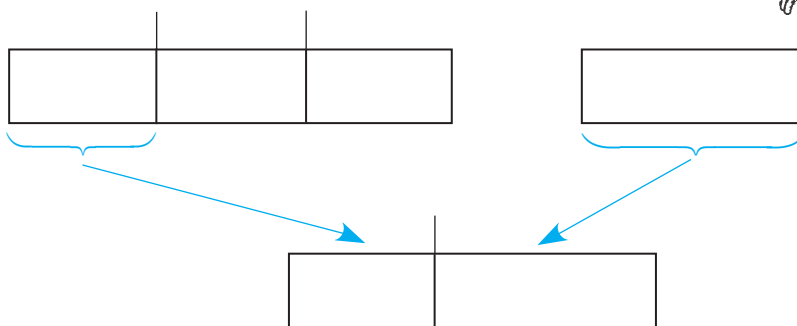

## \*ЗАНЯТКИ 19

1



# Л л

ла лу ло лі лэ лы  
лі лэ ла лу лы ла

2

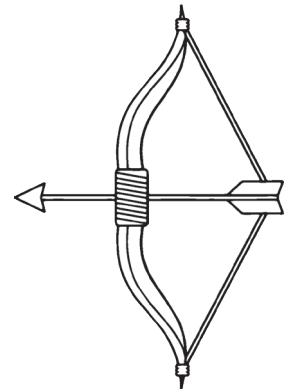
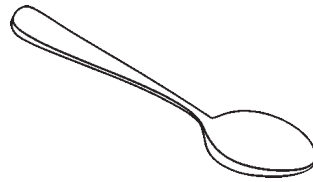
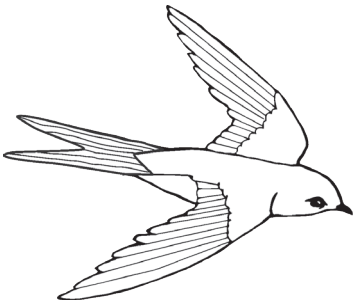

ла

лы

лі

лу

ло

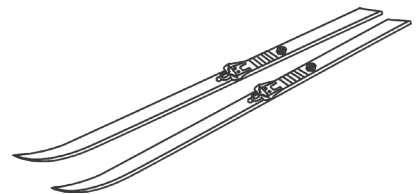
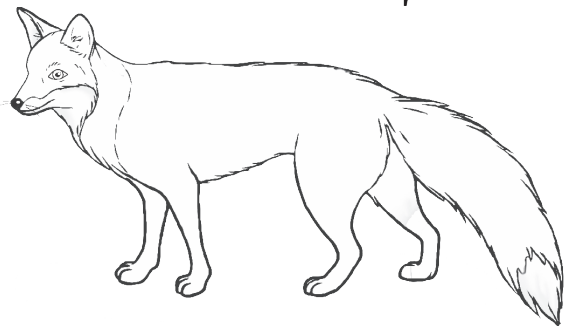

3



Ла-ла-ла — ...

Лы-лы-лы — ...

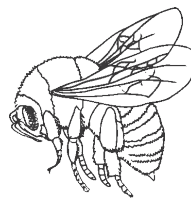

## ЗАНЯТКИ 20

1

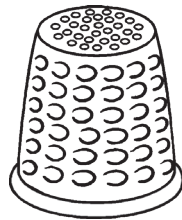
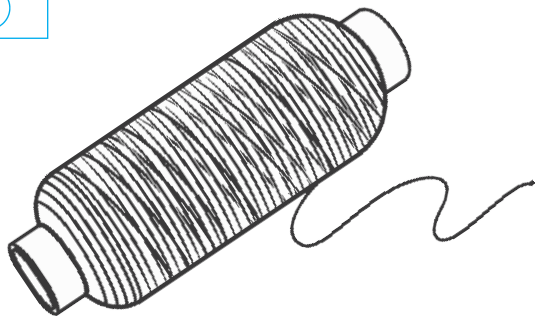

2

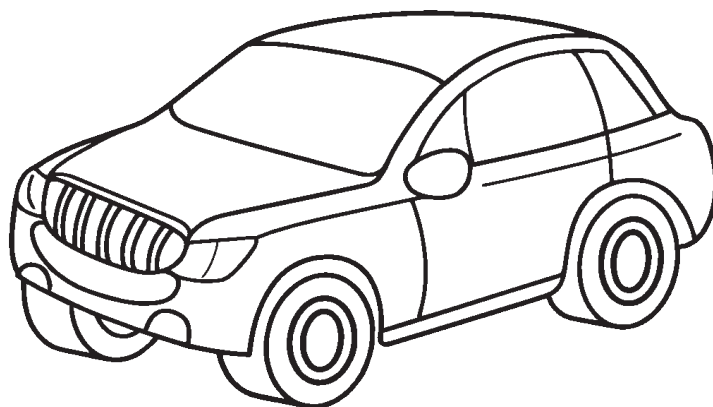
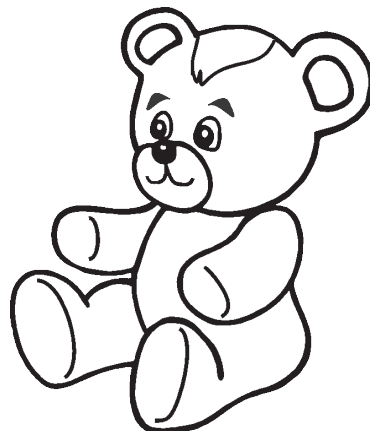
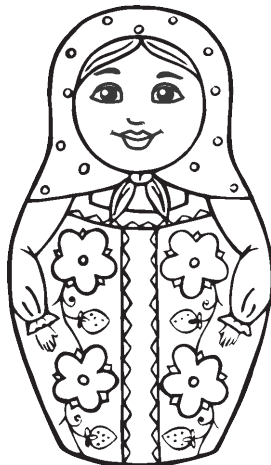



## \*ЗАНЯТКІ 20

1



# Н Н

на но ну ні ны нэ  
ні ну на но нэ ны  
ма мы мо ла лы ло

2



на

ну



ма

мі



ны

ні

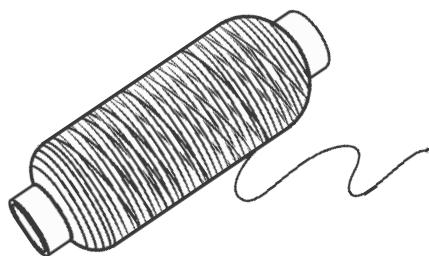

лы

лі

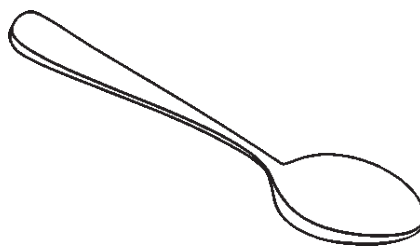

3



Лі

→ на

Но

Ні

→ на

І

мі

→ ма

Э

# ЗАНЯТКІ 21

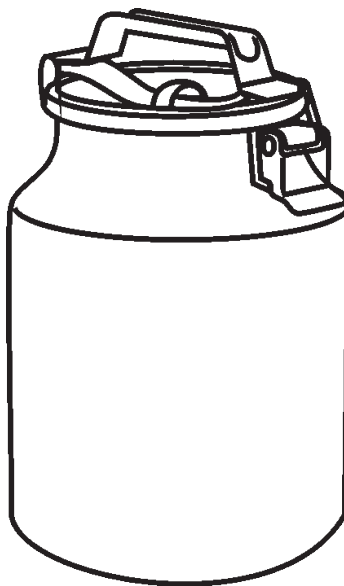
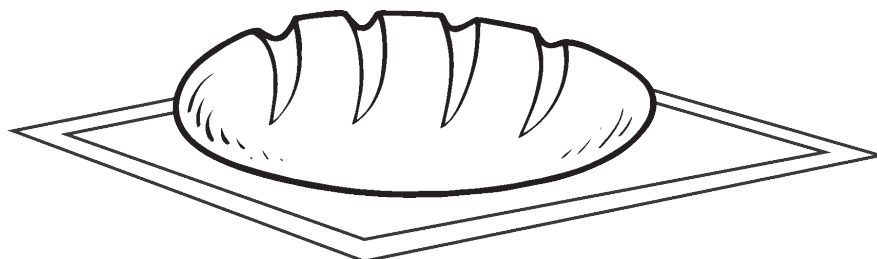

## \*ЗАНЯТКИ 21

1



# Р р

ра ро ру ры рэ ру  
на но ну ны нэ ну ні  
ла ло лу лы лэ лу лі

2

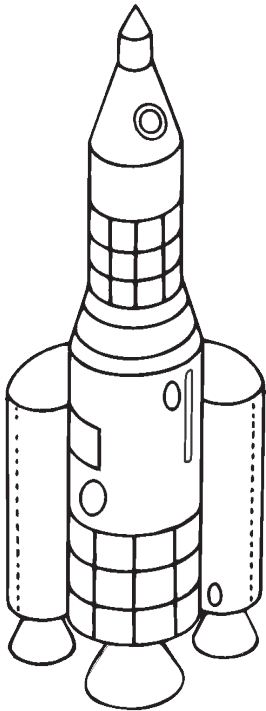

ра

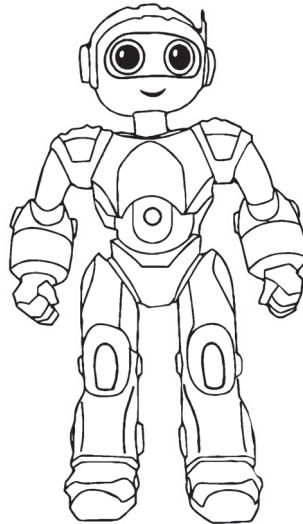

ру

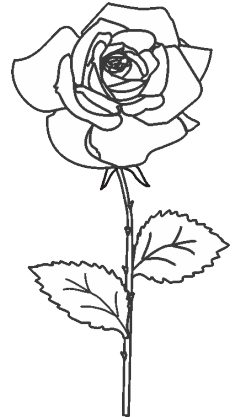

ры

ро

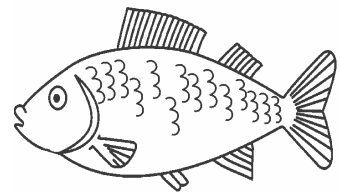

3



ра → ма  
ра → на

мо → ра  
ма → ра  
Ло → ра

## ЗАНЯТКИ 22

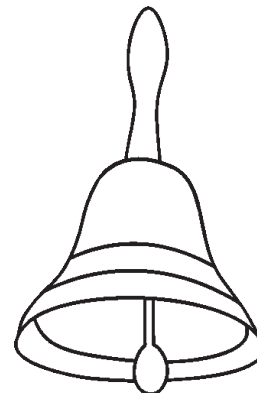
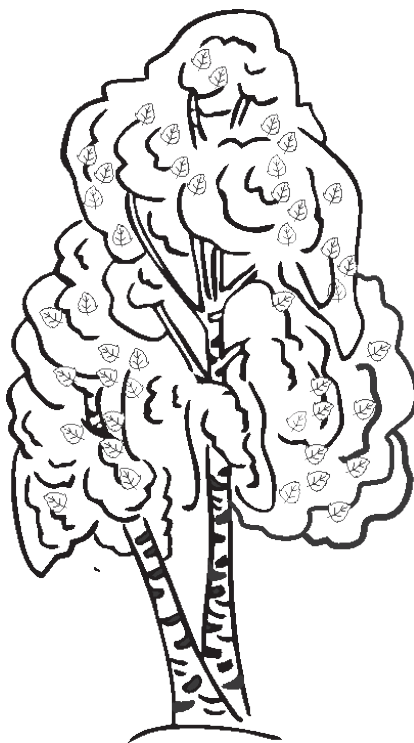
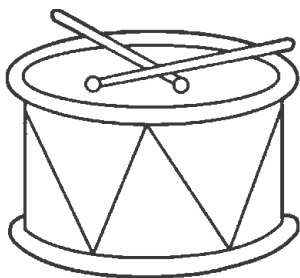
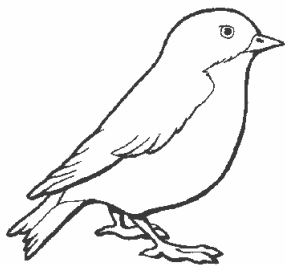

## \*ЗАНЯТКІ 22

1



на	но	ну	ны	нэ	ну	ні
ла	ло	лу	лы	лэ	лу	лі
ма	мо	му	мы	мэ	му	мі
ра	ро	ру	ры	рэ	ру	

2



на

ну

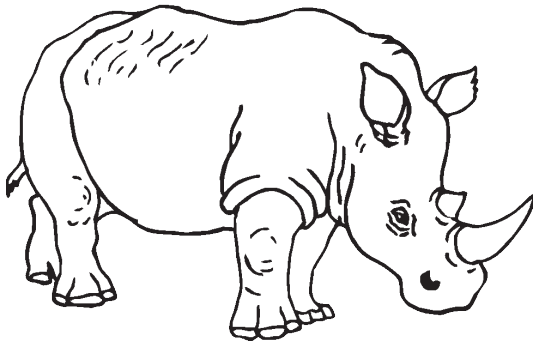

му

мо

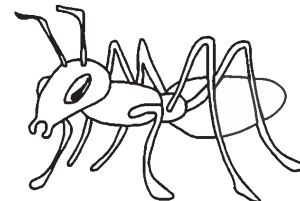

3



р

Ло..а

м

..ама

на..а

..ала

..ана

..ір

# ЗАНЯТКИ 23

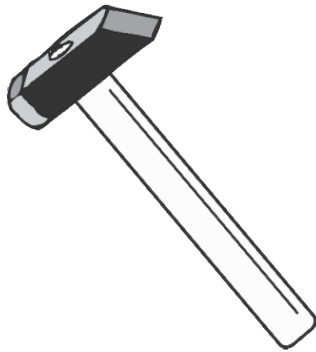
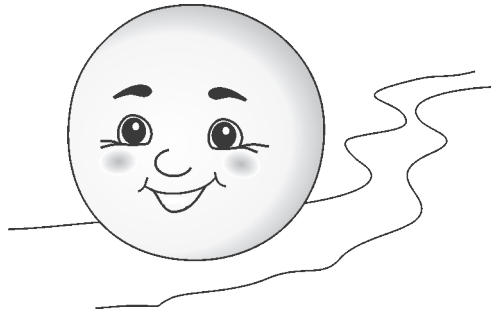
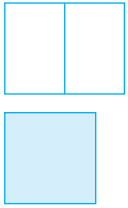

## \*ЗАНЯТКІ 23

1



# К к

ка ку ко кі кэ кы  
лі мэ ра лу ку на

2

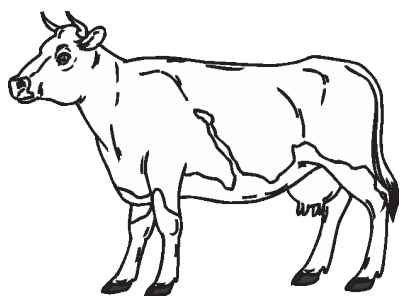

му-му

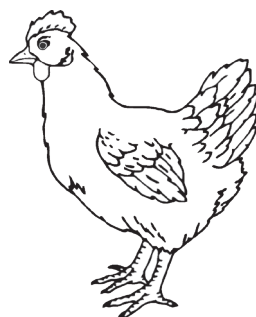

ко-ко-ко



ку-ку

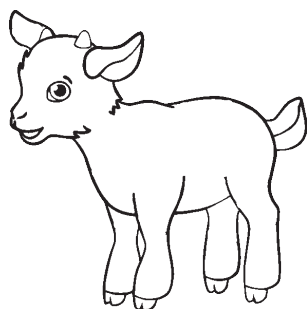

мэ-мэ

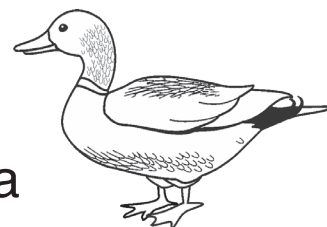

кра-кра

3



Рыма

рана-нара

Рома

мара-рама

Кіра

рака-кара

4

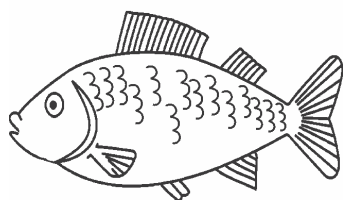

+

# К

# ЗАНЯТКИ 24

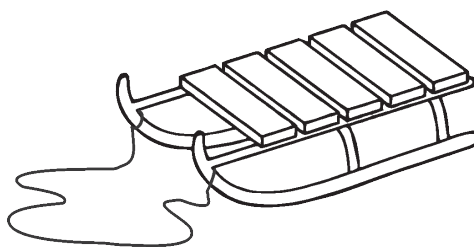
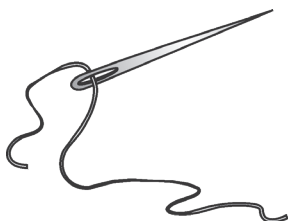

--	--	--	--

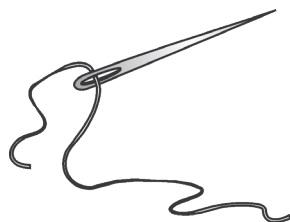
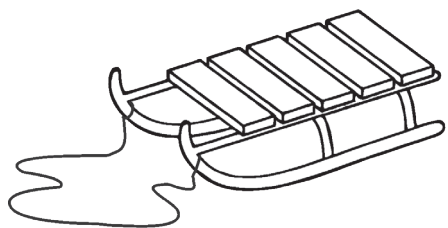

--	--	--	--



# \*ЗАНЯТКИ 24

1

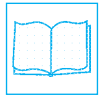

# С с

су сі со са сә сы  
ку кі ка кы кә кы

2



са → ма  
са → ні  
са → ла  
ра → са  
ка → са  
лі → са

3

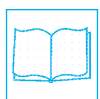

с р

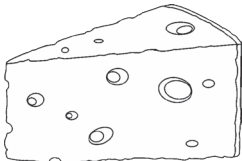

ы

--	--	--

с о

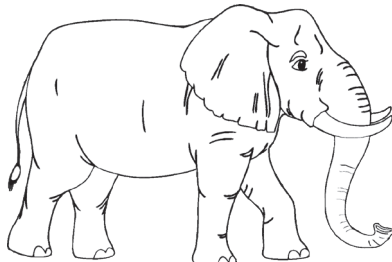

л н

--	--	--	--

с р о

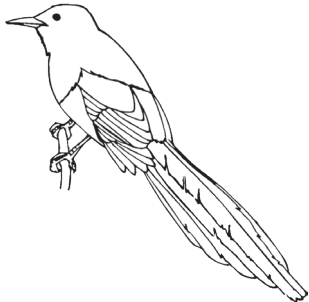

а к а

--	--	--	--	--	--

# ЗАНЯТКИ 25

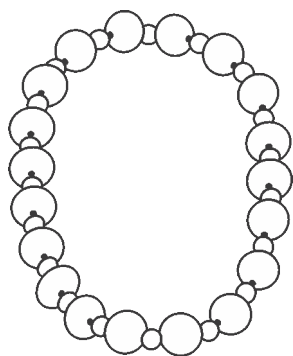

--	--	--	--	--	--

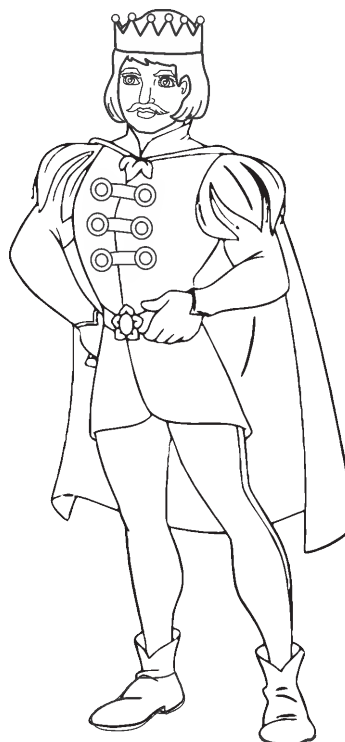
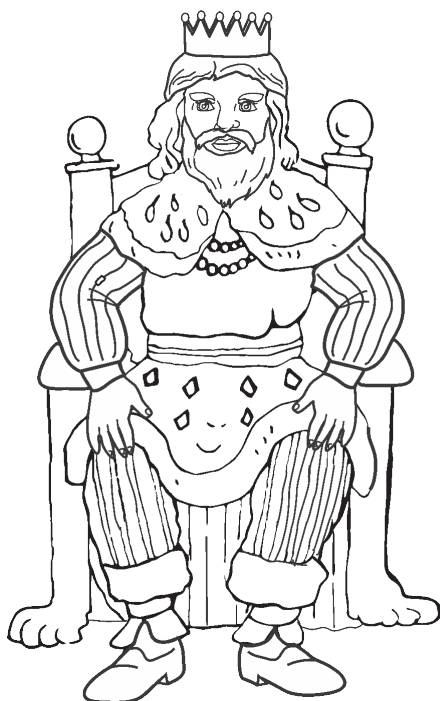

--	--	--	--	--	--

## \*ЗАНЯТКИ 25

1



# З з

за зі зо зу зы зэ  
са со сы су сэ сі

2



лаза зоры сіні  
каза узоры асіна

3

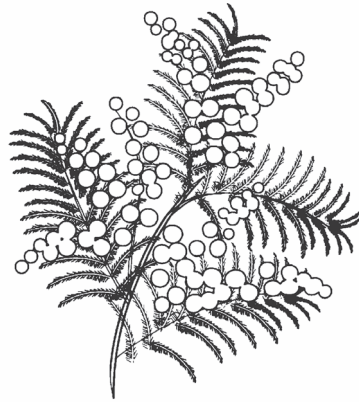
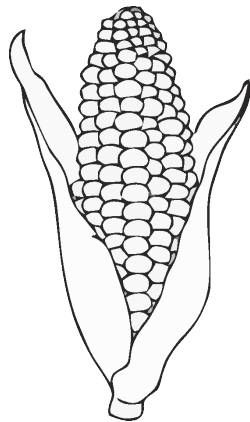

мак мімоза рамонак кукуруза



# ЗАНЯТКИ 26

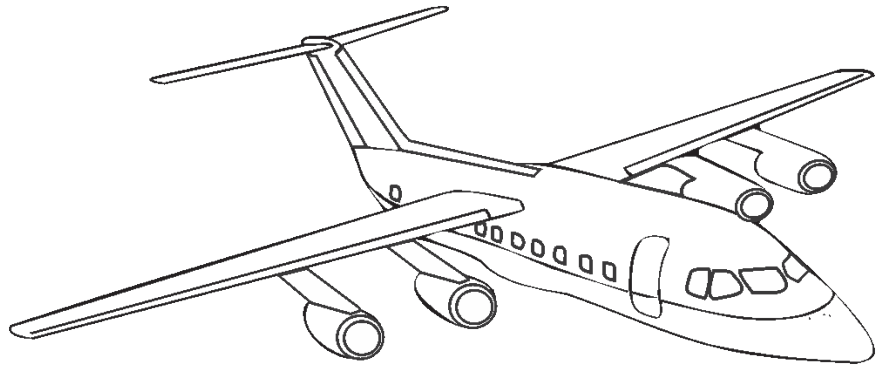
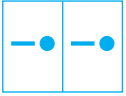

--	--	--

--	--	--

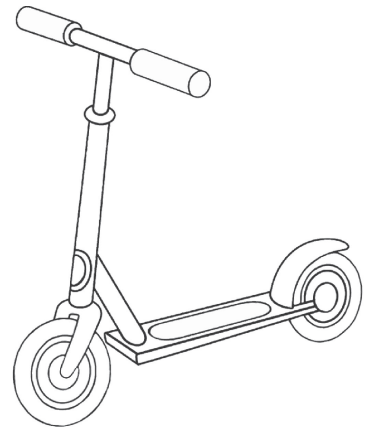
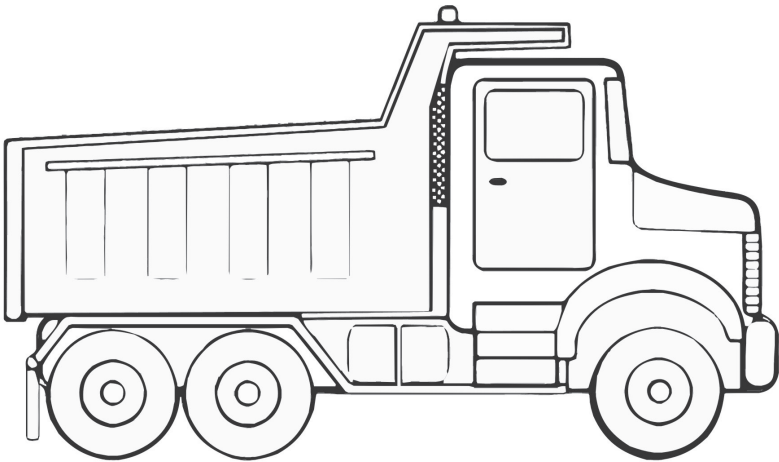

--	--	--

--	--	--

## \*ЗАНЯТКИ 26

1



Ш ш

ша

шу

шы

шэ

шо

2



ша → ры  
ша → рык  
ша → лаш

КОШ → ка  
МЫШ → ка  
міш → ка  
ШЫШ → ка

3



шар

мышка

Шарык

мішка

кош

мушка

КОШЫК

МОШКА

4



ШАЛАШ



# ЗАНЯТКИ 27

1

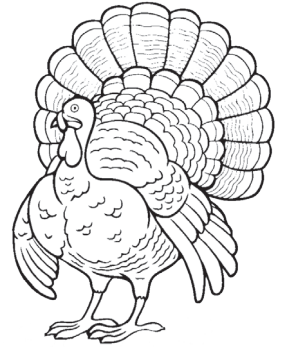
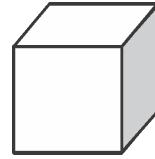
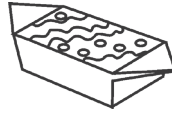
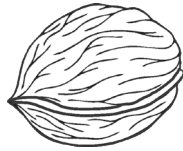
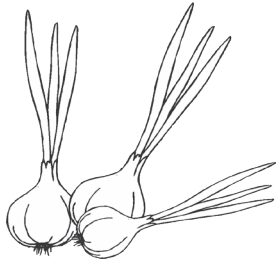

--	--	--	--	--

2



## \*ЗАНЯТКІ 27

1



# Ж ж

жа жу жы жэ жо  
ша шу шы шэ шо

нож нажы  
корж каржы  
кош кашы́

2

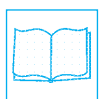

на → жы  
лы → жы

са → жа  
мо → жа

3

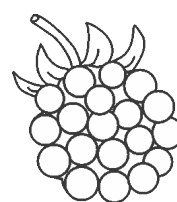
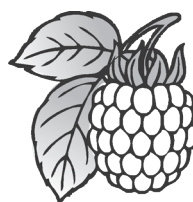
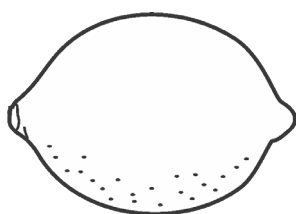
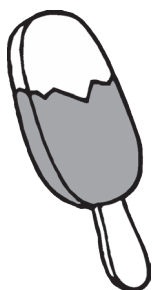

каша малако лімон  
масла эскімо сала  
маліны ажыны сыр

# ЗАНЯТКИ 28

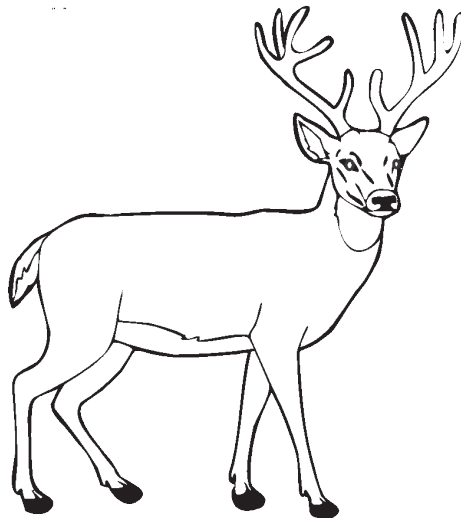
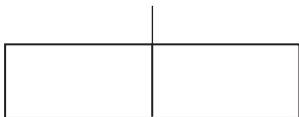
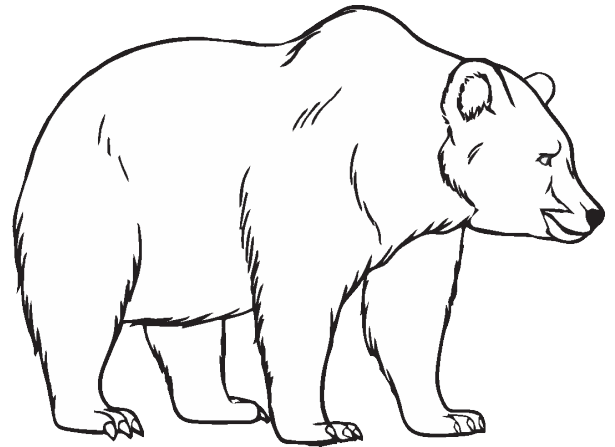
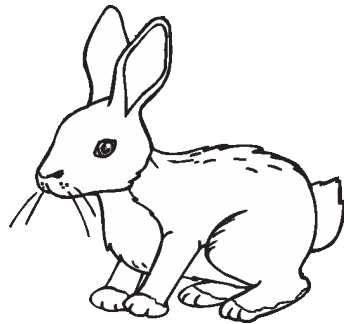
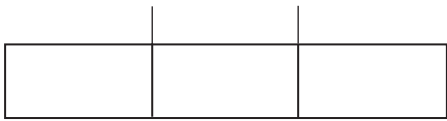
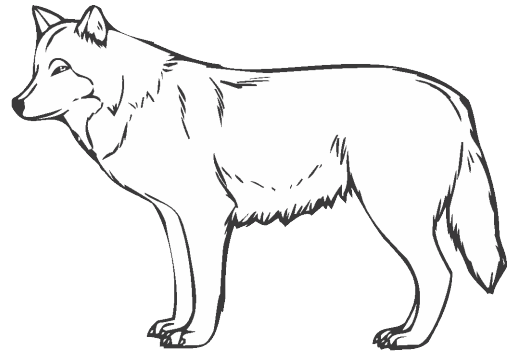
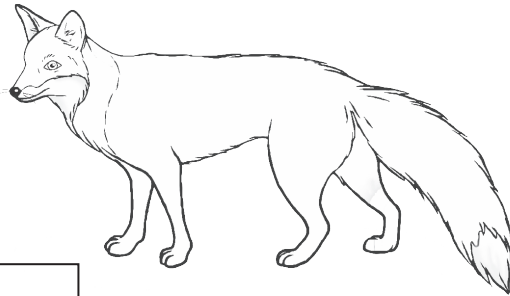



## \*ЗАНЯТКИ 28

1



# Я

за са ма ла на ка ра  
зя ся мя ся ня кя

2



мі

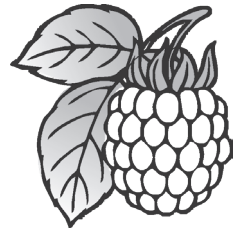

му

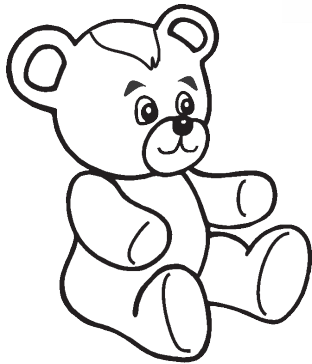

ма

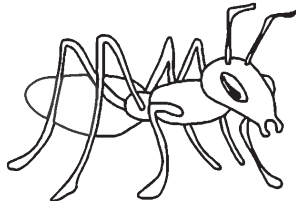

мя

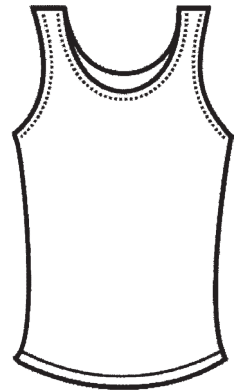

3



Ня-ня-ня — у кошки ...

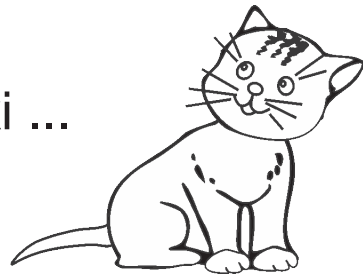

Ля-ля-ля — у ...

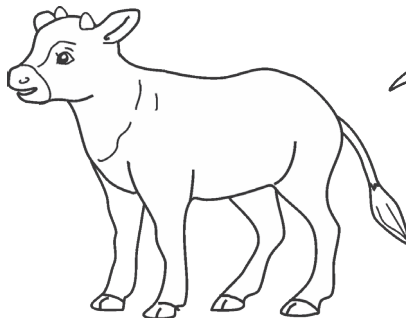

# ЗАНЯТКИ 29

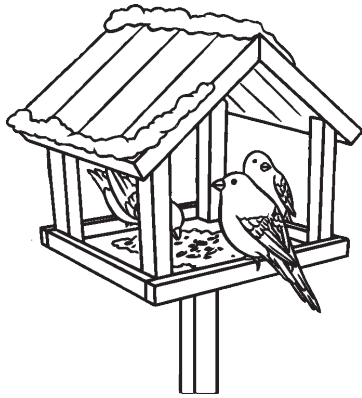
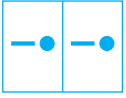

--	--	--

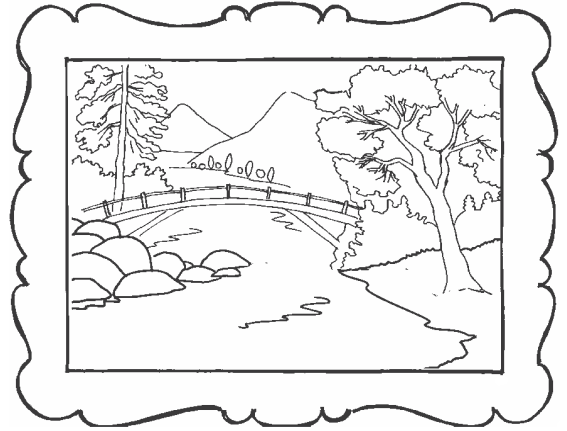

--	--	--



--	--



--

## \*ЗАНЯТКИ 29

1



# Я

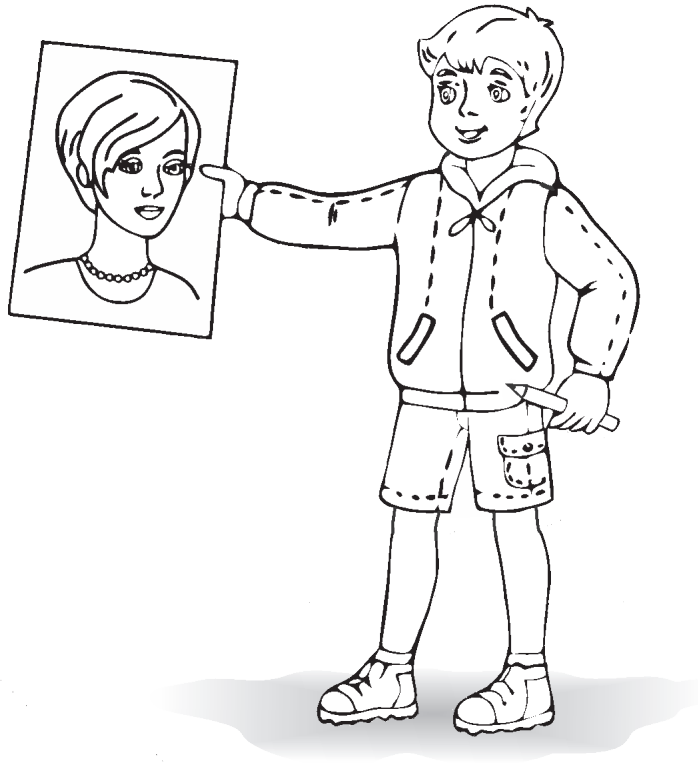

Я і мая мама.

2



А

ма

Я

ня

Ма

на

Ні

я

Ра

ша

Мі

ся

Зо

# ЗАНЯТКІ 30

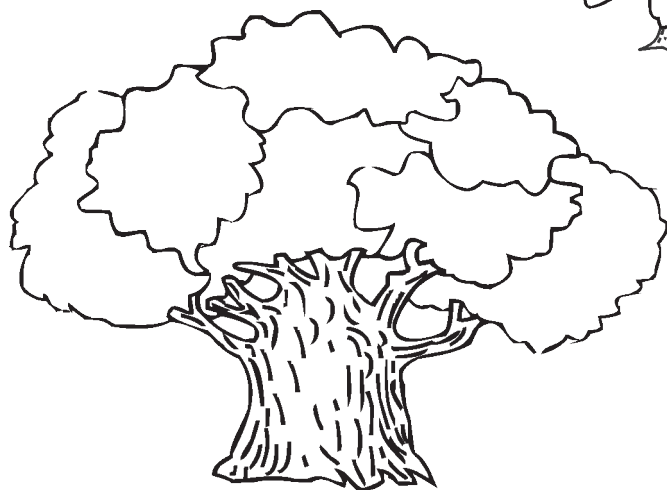
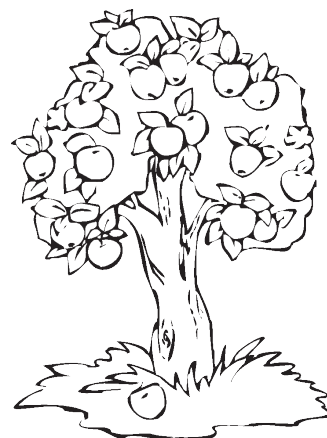
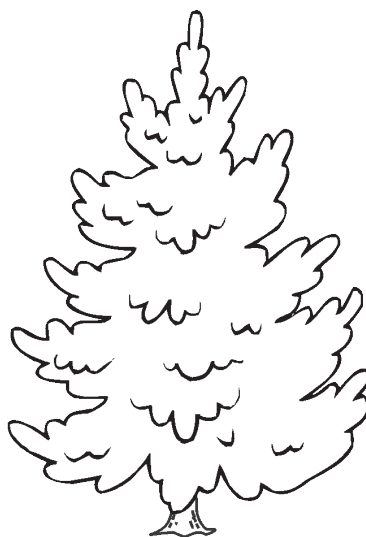
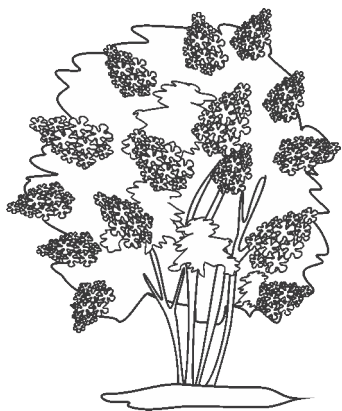

Blank area for drawing or coloring, indicated by a pencil icon in the top left corner.

## \*ЗАНЯТКИ 30

1



П п

па по пэ пу пі пы  
пя па пу па по пі

2



рэ шап Палі  
лі па пуш ка на  
ла пал машы

3

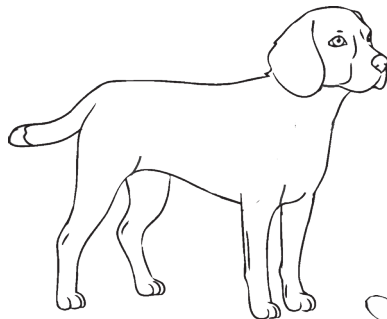

Пушок

Зорка

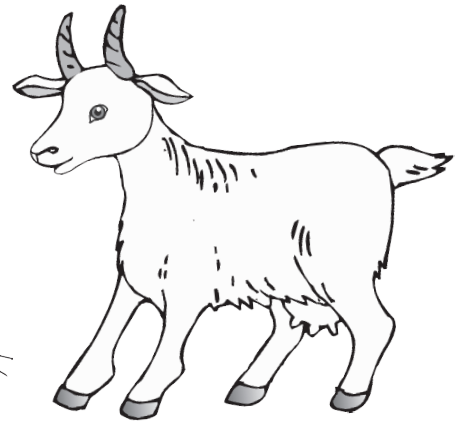
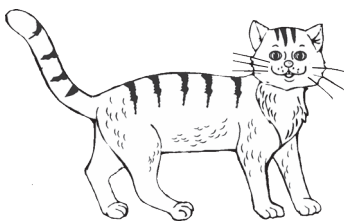

Палкан

# ЗАНЯТКИ 31

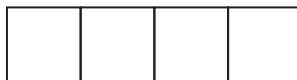
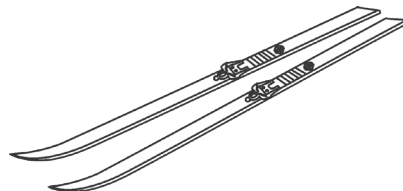
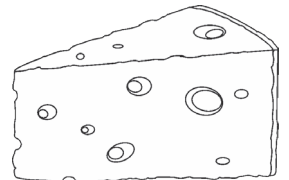
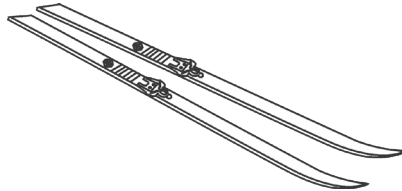
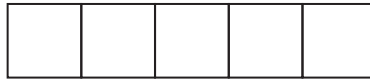
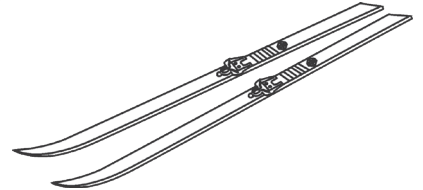
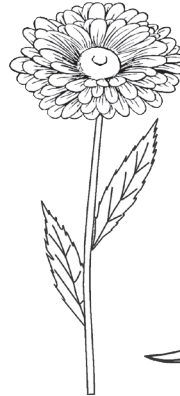
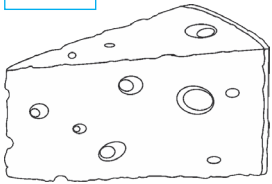

\*ЗАНЯТКІ 31

1



Б б

па по пэ пу пі пя  
ба бо бэ бу бі бя

---

2



барс барбарыс  
баран барсук  
барабан

---

3



б ..ант  
..атон  
зе..ра а..аранак

---

# ЗАНЯТКИ 32

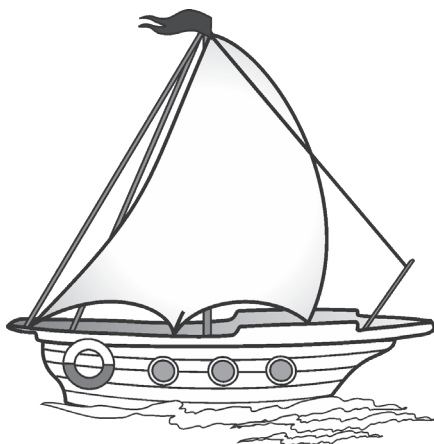
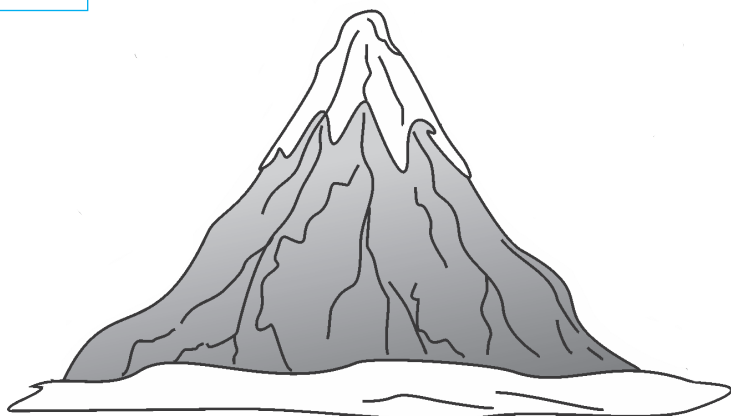
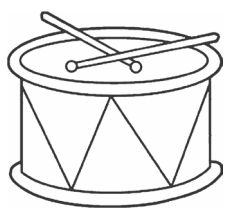
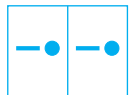



## \*ЗАНЯТКІ 32

1



# Е е

мэ сэ нэ лэ зэ кэ рэ  
ме се не ле зе ке

2



Ніна Коля  
Міла Жэня  
Лена Соня

3



Ева

Зоя

Рая

Яна

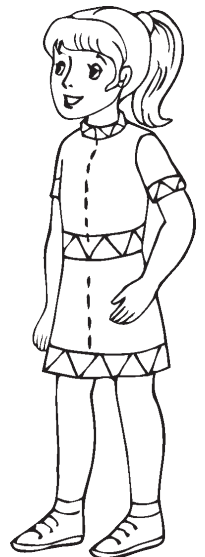
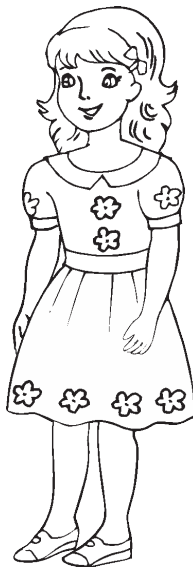

--	--	--	--	--	--

--	--	--	--	--	--

# ЗАНЯТКІ 33

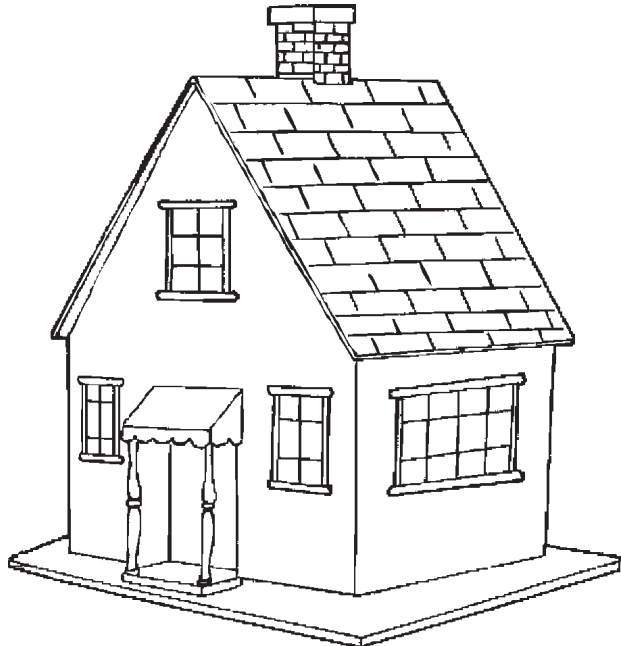
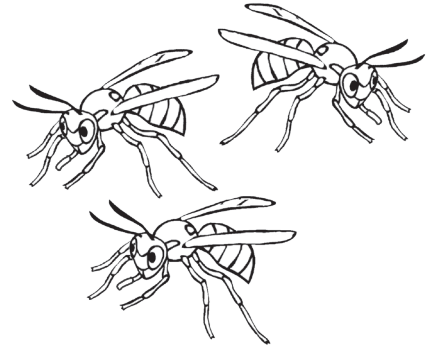
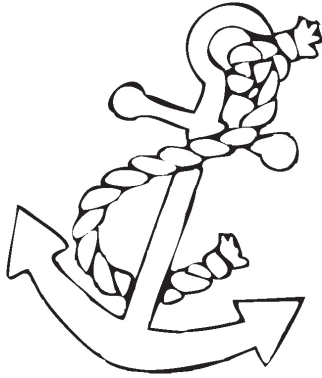
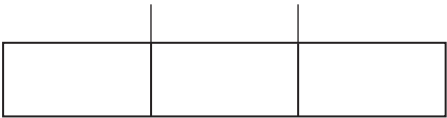
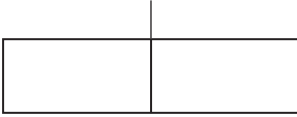

## \*ЗАНЯТКИ 33

1



# Й

май

майка

мый

зайка

мой

байка

2



музе  $\begin{matrix} \nearrow i \\ \searrow й \end{matrix}$

3



зайка

сарока

сойка

бусел

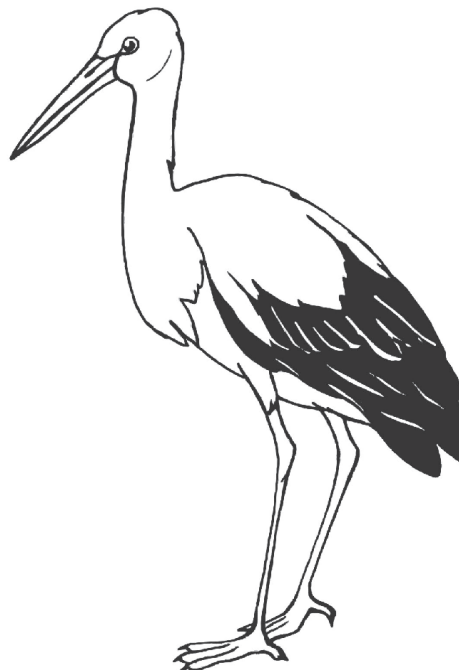

# ЗАНЯТКИ 34

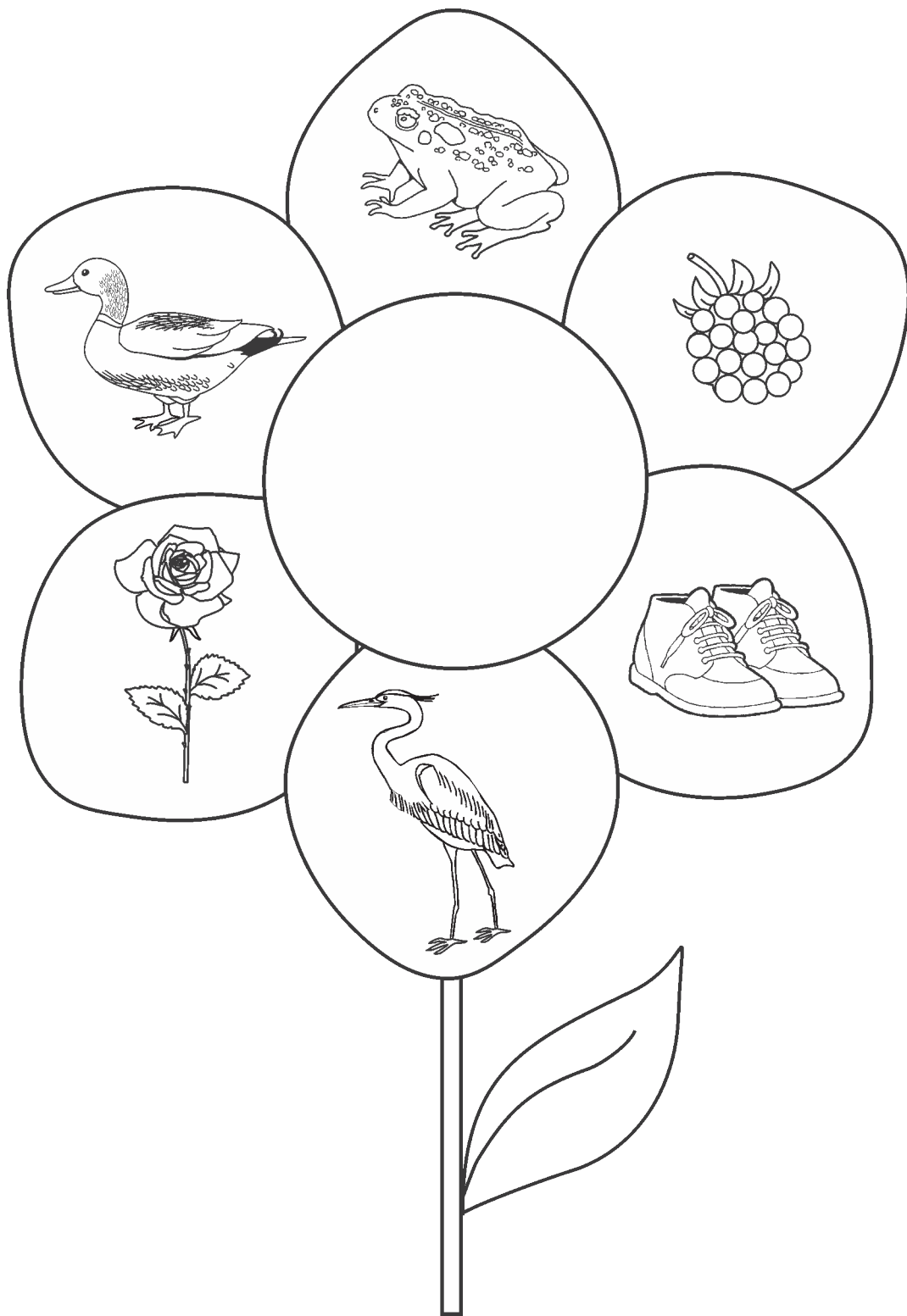

## \*ЗАНЯТКІ 34

1



# Б

алень

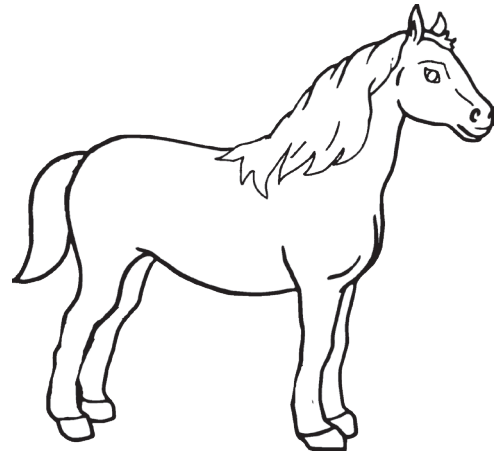
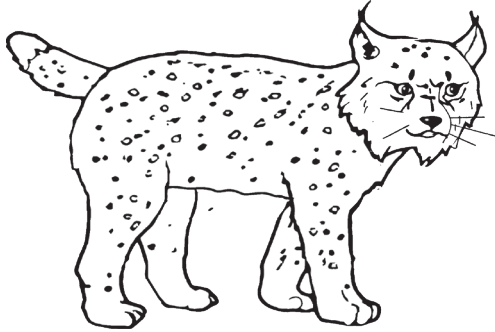

рысь

рыс

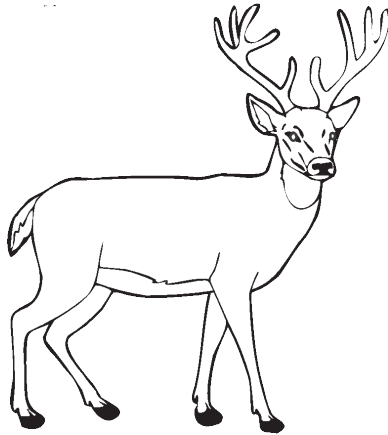

КОНЬ

2



У лесе: рысь, ліса, лось ...

У нас: конь, каза, баран, сабака, кошка ...

3



Лінь, лось, карась, акунь, сом.

# ЗАНЯТКИ 35

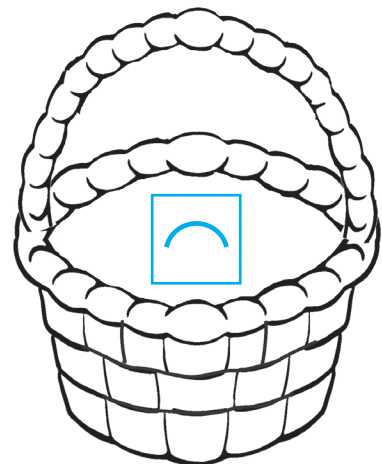
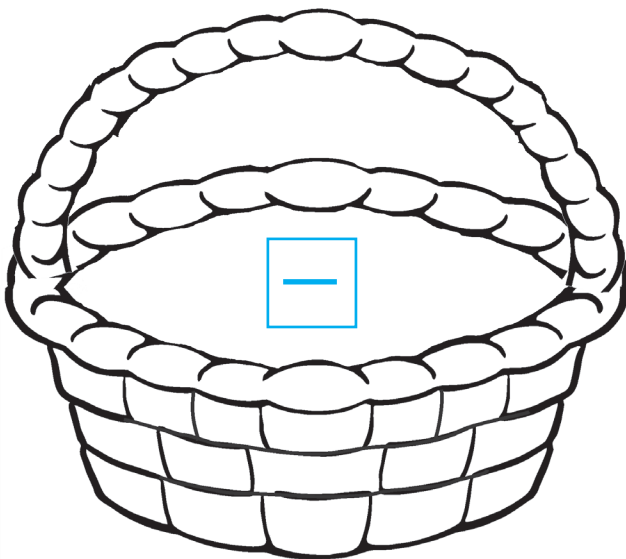
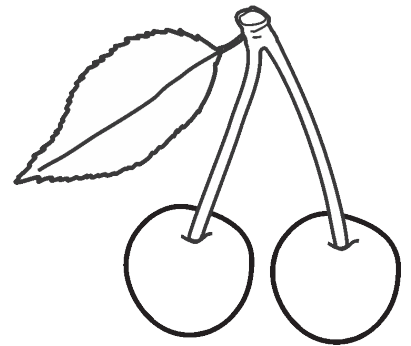
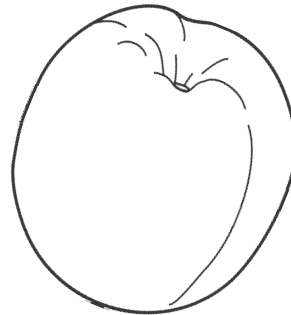
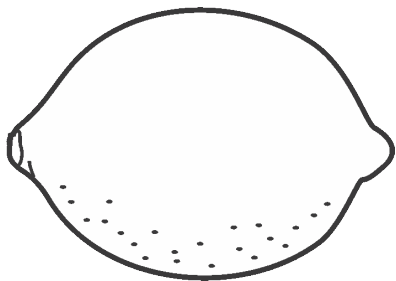
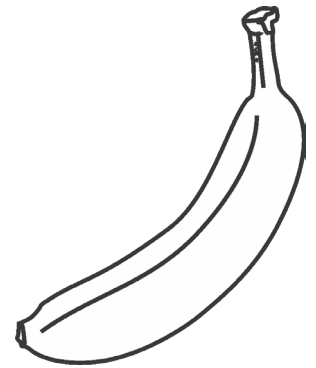
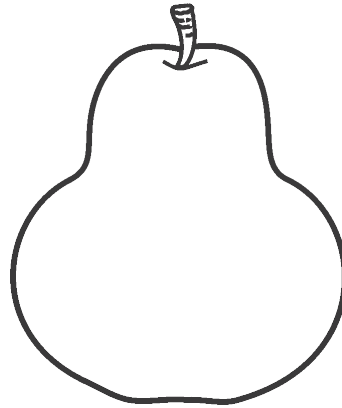

## \*ЗАНЯТКИ 35

1



# В в

ва во ву ве ві вы вя  
га го гу ге гі гы гя

2



варо → на  
→ ты

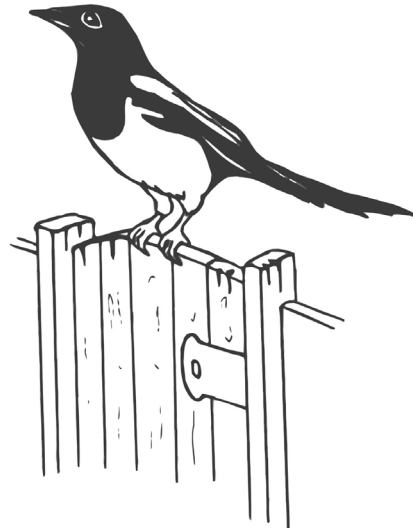

3



слі	ня
віш	ва
сло	на
вяс	вы

4



Каровы: «Му-му!  
Малака каму?»»

# ЗАНЯТКІ 36

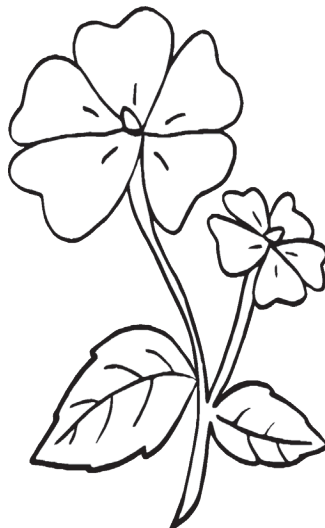
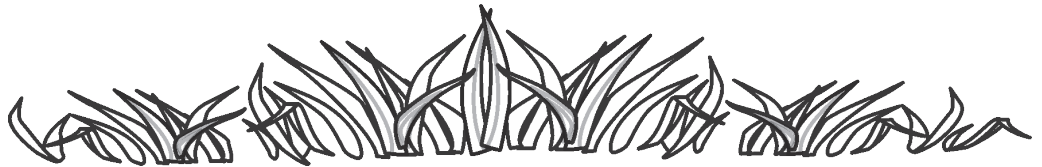
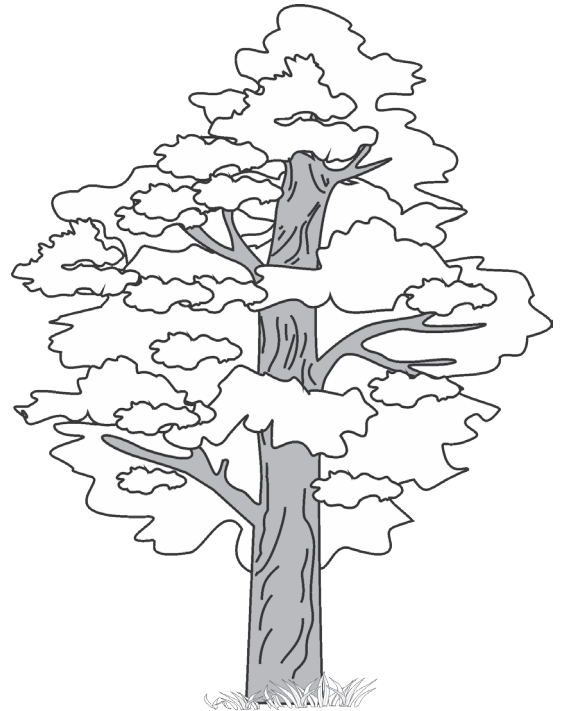
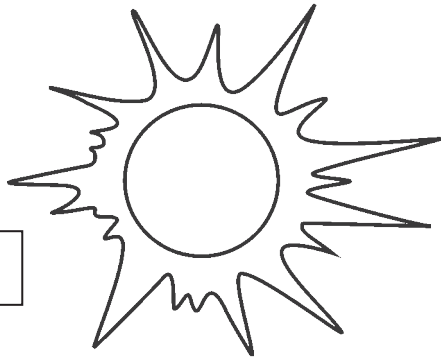



## \*ЗАНЯТКИ 36

1



Г г

га

го

гу

ге

гі

гы

гя

2



гя

гу

гы

га

го

ге

гі

		р	ы
--	--	---	---

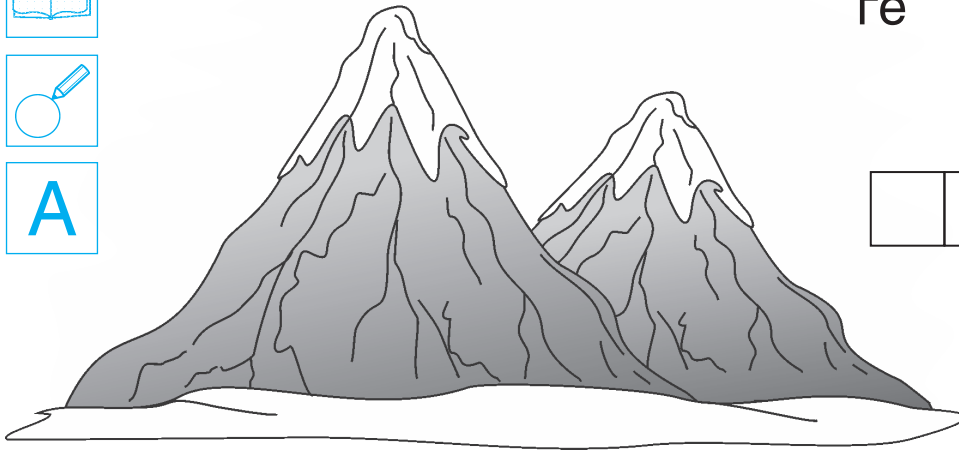

3



ногі

рог

рогі

гук

гара

луг

Галя

гол

4

Г

..орн

..усь



..ліна

..рыб

Вучэбнае выданне

ВМК «Мае першыя ўрокі»

**Старжынская** Наталля Сцяпанаўна

## **ПАДРЫХТОЎКА ДА НАВУЧАННЯ ГРАМАЦЕ**

Рабочы сшытак

Вучэбны дапаможнік  
для выхаванцаў старшых груп (ад 5 да 7 гадоў)  
устаноў дашкольнай адукацыі  
з беларускай мовай навучання

Нач. рэдакцыйна-выдавецкага аддзела *Г. І. Бандарэнка*

Рэдактар *Л. Ф. Леўкіна*

Мастакі *Н. А. Хромава, А. М. Кісялёў*

Мастацкі рэдактар *А. П. Пратасеня*

Камп'ютарная вёрстка *А. М. Кісялёва*

Карэктары *Д. Р. Лосік, Н. В. Федарэнка*

Падпісана да друку 25.02.2020. Фармат 84×108<sup>1</sup>/<sub>16</sub>. Папера афсетная.

Друк афсетны. Ум. друк. арк. 8,4. Ул.-выд. арк. 8,5.

Тыраж 12 972 экз. Заказ

Навукова-метадычная ўстанова «Нацыянальны інстытут адукацыі»

Міністэрства адукацыі Рэспублікі Беларусь.

Пасведчанне аб дзяржаўнай рэгістрацыі выдаўца, вытворцы, распаўсюджвальніка  
друкаваных выданняў № 1/263 ад 02.04.2014.

Вул. Караля, 16, 220004, г. Мінск

Мінскае абласное ўнітарнае прадпрыемства «Барысаўская ўзбуйненая друкарня імя 1 Мая».

Пасведчанне аб дзяржаўнай рэгістрацыі выдаўца, вытворцы, распаўсюджвальніка  
друкаваных выданняў № 2/13 ад 21.11.2013.

Вул. Будаўнікоў, 33, 222120, г. Барысаў